

| | |
|--|-----------|
| Warranty | 2 |
| Important Safety Instructions | 3 |
| Environmental Information | 4 |
| Introduction | 4 |
| Planning the Installation | 7 |
| Speaker Position | 7 |
| Surround Speaker Dispersion Mode | 8 |
| Mounting the Speakers | 9 |
| CT8 DS - Installation Into Drywall | 11 |
| CD8 DS - Installation to Wall Surface | 12 |
| Connecting the System | 14 |
| CT8 XO Mk2 Wiring Diagram | 15 |
| The CT8 OX Mk2 Crossover/Equaliser | 15 |
| Description of Controls | 16 |
| Equipment Required | 17 |
| Configuring the CT8 XO to the speaker | 17 |
| Configuring the Unit to the Gain of Each Power Amplifier | 17 |
| Configuring the Equalisers | 18 |
| Running In and Ancillary Equipment | 22 |
| Aftercare | 22 |
| Technical Specifications | 23 |

Warranty

Dear customer,

Welcome to B&W.

This product has been designed and manufactured to the highest quality standards. However, if something does go wrong with this product, B&W Group Ltd and its national distributors warrant free of charge labour (exclusion may apply) and replacement parts in any country served by an official B&W distributor.

Limited Warranty

This limited warranty is valid for a period of five years from the date of purchase or two years for electronics including amplified loudspeakers.

Terms and Conditions

- 1 The warranty is limited to the repair of the equipment. Neither transportation, nor any other costs, nor any risk for removal, transportation and installation of products is covered by this warranty.
- 2 This warranty is only valid for the original owner. It is not transferable.
- 3 This warranty will not be applicable in cases other than defects in materials and/or workmanship at the time of purchase and will not be applicable:
 - a) for damages caused by incorrect installation, connection or packing,
 - b) for damages caused by any use other than correct use described in the user manual, negligence, modifications, or use of parts that are not made or authorised by B&W,
 - c) for damages caused by faulty or unsuitable ancillary equipment,
 - d) for damages caused by accidents, lightning, water, fire heat, war, public disturbances or any other cause beyond the reasonable control of B&W and its appointed distributors,
 - e) for products whose serial number has been altered, deleted, removed or made illegible,
 - f) if repairs or modifications have been executed by an unauthorised person.
- 4 This guarantee complements any national/regional law obligations of dealers or national distributors and does not affect your statutory rights as a customer.

How to claim repairs under warranty

Should service be required, please follow the following procedure:

- 1 If the equipment is being used in the country of purchase, you should contact the B&W authorised dealer from whom the equipment was purchased.
- 2 If the equipment is being used outside the country of purchase, you should contact B&W national distributor in the country of residence who will advise where the equipment can be serviced. You can call B&W in the UK or visit our web site to get the contact details of your local distributor.

To validate your warranty, you will need to produce the warranty booklet, completed and stamped by your dealer on the date of purchase. Alternatively, you will need the original sales invoice or other proof of ownership and date of purchase.

Important Safety Instructions

WARNINGS:

- 1 Read these instructions.
- 2 Keep these instructions.
- 3 Heed all warnings.
- 4 Follow all instructions.
- 5 Do not use this apparatus near water.
- 6 Clean only with dry cloth.
- 7 Do not block any ventilation openings. Install in accordance with the manufacturer's instructions.
- 8 Do not install near any heat sources such as radiators, heat registers, stoves, or other apparatus (including amplifiers) that produce heat.
- 9 Do not defeat the safety purpose of the polarized or grounding-type plug. A polarized plug has two blades with one wider than the other. A grounding type plug has two blades and a third grounding prong. The wide blade or the third prong are provided for your safety. If the provided plug does not fit into your outlet, consult an electrician for replacement of the obsolete outlet.
- 10 Protect the power cord from being walked on or pinched particularly at plugs, convenience receptacles and the point where they exit from the apparatus.
- 11 Only use attachments/accessories specified by the manufacturer.
- 12  Use only with the cart, stand, tripod, bracket, or table specified by the manufacturer, or sold with the apparatus. When a cart is used, use caution when moving the cart/apparatus combination to avoid injury from tip-over.
- 13 Unplug this apparatus during lightning storms or when unused for long periods of time.
- 14 Refer all servicing to qualified service personnel. Servicing is required when the apparatus has been damaged in any way, such as power-supply cord or plug is damaged, liquid has been spilled or objects have fallen into the apparatus, the apparatus has been exposed to rain or moisture, does not operate normally, or has been dropped.
- 15 Do not expose this apparatus to dripping or splashing and ensure that no objects filled with liquids, such as vases, are placed on the apparatus.
- 16 To completely disconnect this apparatus from the AC Mains, disconnect the power supply cord plug from the AC receptacle.
- 17 The mains plug of the power supply cord shall remain readily operable.
- 18 When replacement parts are required, be sure the service technician has used replacement parts specified by the manufacturer or have the same characteristics as the original part. Unauthorised substitutions may result in fire, electric shock or other hazards.
- 19 For continued protection against fire hazard, use fuses only of the correct type and rating.
- 20 This product should be operated only from the type of power source indicated by the marking adjacent to the power cord entry. If you are not sure of the type of power supply to your home, consult your product dealer or local power company.
- 21 Do not overload wall outlets, extension cords or integral convenience receptacles, as this can result in a risk of fire or electric shock.
- 22 Never push objects of any kind into this product through openings, as they may touch dangerous voltage points or short out parts that could result in a fire or electric shock. Never spill liquid of any kind on the product. Do not place any object containing liquid on top of the product.

Caution:

To reduce the risk of electric shock, do not dismantle the apparatus and do not expose the apparatus to rain or moisture. No user-serviceable parts inside. Refer servicing to qualified personnel.



Explanation of Graphical Symbols



The lightning flash within an equilateral triangle is intended to alert you to the presence of uninsulated "dangerous voltage" within the product's enclosure that may be of sufficient magnitude to constitute an electric shock to persons.



The exclamation point within an equilateral triangle is intended to alert you to the presence of important operating and maintenance (servicing) instructions in the literature accompanying the appliance.

Environmental Information

All B&W products are designed to comply with international directives on the Restriction of Hazardous Substances (RoHS) in electrical and electronic equipment and the disposal of Waste Electrical and Electronic Equipment (WEEE).



These symbols indicate compliance and that the products must be appropriately recycled or processed in accordance with these directives. Consult your local waste disposal authority for guidance.

Introduction

Thank you for purchasing a Bowers and Wilkins Custom Theatre system.

Since its foundation in 1966, the continuing philosophy of B&W has been the quest for perfect sound reproduction. Inspired by the company's founder, the late John Bowers, this quest has entailed not only high investment in audio technology and innovation but also an abiding appreciation of music and movies to ensure that the technology is put to maximum effect.

Custom Theatre speakers are specifically designed to be built into the fabric of the listening room or into custom furniture as part of a fully designed theatre concept. To that end, they incorporate several features that enable them to be adapted to a wide range of installation conditions and deliver superb sound quality. However, they specifically do not incorporate features found on some other B&W products that are not appropriate to this type of installation. An example of such a feature would be tweeter on top, which only operates well with a free-standing speaker. Furthermore, because of the normal custom install practice of hiding built-in speakers with acoustically transparent cloth that matches the décor, all the models except one are supplied without grilles. The exception is the CT8 DS surround speaker, which needs to protrude into the room in order for the side-firing drivers to operate properly.

No matter how good the speakers themselves may be, they will not deliver their full potential unless properly installed. Please read through this manual fully. It will help you optimise the performance of the system.

B&W distributes to over 60 countries worldwide and maintains a network of dedicated distributors who will be able to help should you have any problems your dealer cannot resolve.

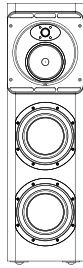
**CT8 LR**

A 3-way speaker intended for front left and right channels, one placed in vertical orientation at each side of the screen.

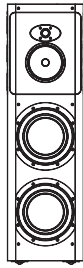
**CT8 DS**

A full range surround speaker that may operate in either 2-way dipole or 3-way monopole mode.

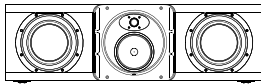
**CT8 CC**

A 3-way centre channel speaker that is acoustically similar to the CT8 LR, but designed with a more symmetrical drive unit layout so that it may be used in horizontal orientation immediately above or below the screen.

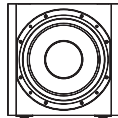
**CT8 SW**

A subwoofer that may be added to any or all the above three models to extend their bass response well below the accepted lower limit on human hearing.

**CT8 XO Mk2**

An active, line-level crossover/equaliser that:

- is required for each CT8 LR, CT8 CC and CT8 DS and must be configured to the particular speaker type.
- provides active filtering between midrange and bass drivers and between bass drivers and CT8 SW (if used).
- controls whether a surround speaker operates in dipole or monopole mode and, in dipole mode, controls the direction of the positive and negative polarity lobes.
- provides high- and low-frequency level control, plus three adjustable parametric equalisers to adjust for speaker/room interference effects.

Although the speakers are semi-active and require an active crossover, all power amplification must be separately sourced. Each CT8 LR, CT8 CC and CT8 DS requires two channels of power amplification, or three if used with a CT8 SW subwoofer. This allows the user maximum flexibility in choosing these components.

The CT8 SW subwoofer, unlike the majority of subwoofers currently available, does not contain its own power amplifier and is used in a different manner than is usual. The original concept of home theatre based on various Dolby Digital and DTS systems advocates five or more main channels plus a single Low Frequency Effects (LFE) channel. The main channels contain full range signals and the LFE channel contains special effects up to approximately 140Hz. Recognising that many people do not want five or more full-range speakers in one room, Dolby Digital and DTS systems allow for the main channels to operate with small speakers having a restricted bass extension. The lowest frequencies from these channels are filtered off and added to the LFE channel to be reproduced by a subwoofer. The filter cut-off frequency is normally set at around 80Hz, the rationale being that sound gets progressively less directional the lower the frequency and localisation becomes less important. This is true to some extent, but the ears can process directional information at very low frequencies and the more the bass of the main channels is extended, the more realistic the sound stage becomes. Many high-end processors offer lower filter cut-off frequencies for this very reason.

To preserve this directional information, a CT8 SW may be added to each of the main channels as desired, extending the frequency response well below 20Hz. The minimum recommended configuration is to assign one subwoofer to each of the front left and right channels, restoring some directional information to the action directly on the screen and full directional information to 2-channel audio programme. The sense of spatial acoustic improves as more subwoofers are added to the remaining channels. If higher sound levels are required for larger listening environments and greater realism, up to two subwoofers may be added to each main channel. (It should be noted here that the addition of more subwoofers to any single channel requires an adjustment of the subwoofer output level of that channel's CT8 XO in order to restore the correct tonal balance.) The LFE channel is then distributed to all the main channels that have a subwoofer assigned by the simple action of configuring the surround processor as if there were no subwoofer present and specifying where the LFE signal should be routed. Strictly speaking, the phrase "no subwoofer" here means "no subwoofer dedicated to the LFE channel".



Safety Warning!

A CT800 system is capable of producing very high sound pressure levels. Prolonged exposure to high sound levels can lead first to temporary and later permanent hearing damage. Do not exceed recommended Leq (equivalent sound level) exposure levels, for example, those specified in ISO 1999:1990.

Figure 1

| | Foot Position Template | Wall Position Template | Torx® key | Retaining bracket kit | Neutrik® 4-pole Speakon® plug | Power Cord |
|--------|------------------------|------------------------|-----------|-----------------------|-------------------------------|------------|
| CT8 LR | ● | ● | ● | | ● | |
| CT8 CC | ● | ● | ● | | ● | |
| CT8 DS | ● | ● | ● | ● | ● | |
| CT8 SW | ● | ● | ● | | ● | |
| CT8 XO | | | | | | ● |

Figure 2

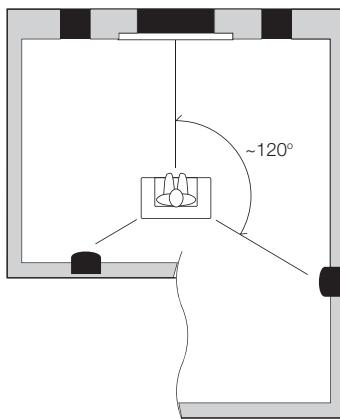

Figure 3

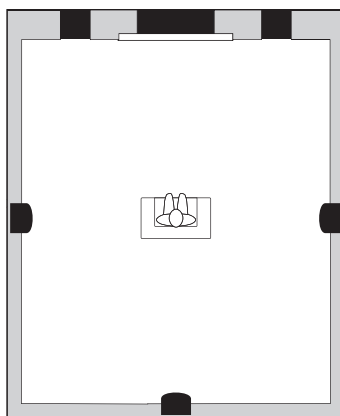
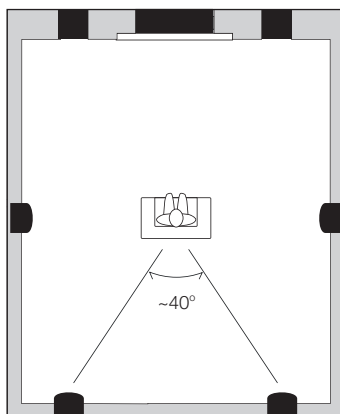

Figure 4



Check the contents against Figure 1

Planning the Installation

Because of the built-in nature of the installation, the planning stage is of the utmost importance. Any need to adjust speaker position, for example, is a much more involved process than with free-standing speakers. Care must also be taken to construct proper support for the speakers. It is all too easy to induce the panels of custom furniture to vibrate and colour the sound unless precautions are taken to prevent it.

Speaker Position

Figures 2 to 4 show the recommended locations in plan view for the main speakers in 5.1, 6.1 and 7.1 channel installations. Some dimensions are marked ~, indicating that there is some latitude allowed each side of the figure, and some have a recommended range for optimum results. Subwoofers should be placed close to the main speakers to which they are assigned.

For successful operation of the surround speaker, CT8 DS, in dipole mode, it is important that all listeners sit within the speaker's null zone. This is the 60° wide zone of low direct sound level created by the opposing polarity drivers on each side. You will notice from figures 3 and 4 that for 6.1 and 7.1 systems, the side speakers are shown in line with the centre of the listening area. This is suitable regardless of whether these speakers are used in dipole or monopole mode. However, for 5.1 systems, the two surround speakers should be placed somewhat behind the listeners for effective results in monopole mode, or if you wish to switch between monopole and dipole modes for different types of programme. If you only ever intend to use them in dipole mode, the two surround speakers should revert to the in-line position. Please read the discussion on surround modes in the next section for a clearer understanding of the benefits of each type.

For larger audience sizes, a more even coverage of the surround sound field may be obtained if the surround speakers are elevated above ear height, as in a commercial cinema. In that case, the speakers may be raised so that the midrange/tweeter array is approximately 60cm (2 ft) above seated ear height.

For correct operation of the CT8 DS in dipole mode, it is important not to obstruct the side firing drivers. The speaker should be mounted with at least the front portion containing the side-firing drivers protruding into the room and any customised covering should be acoustically transparent.

Surround Speaker Dispersion Mode

Surround speakers generally fall into two main types – those that one might describe as ‘normal’ speakers - so-called monopoles, where the sound comes from a set of drive units mounted on the front of the enclosure - and those that give a more diffuse sound field, such as dipoles. Each type has its advantages.

Most multi-channel music is recorded with home entertainment in mind and is monitored using monopole surround speakers, whatever the multi-channel recording format. This enables better location of side and rear images, although the formation of such images is never quite as precise as it is between the front speakers.

Most films are originally balanced for cinemas, where a large number of speakers spread around the auditorium are used to create the surround sound field. In that case there are more surround speakers than there are discrete channels of information and a less precise image is created that gives an all-enveloping effect. Dipoles and similar diffuse speakers are better at recreating this type of sound field in the home, but using fewer speakers to do it. Image positioning with these types of speaker is never as precise as it can be with monopoles. However, they do have the advantage of making it easier to balance the system for a larger listening area.

You may well receive conflicting advice from different sources on the best type of surround speaker to use. The truth is that there is no one perfect solution for all situations and the final choice for any given application will be influenced by personal preference.

The CT8 DS is a specialist surround speaker and has the advantage of offering a choice of both monopole and dipole operation. The mode of operation is set by a relay inside the speaker, the state of which is controlled from the CT8 XO crossover/equaliser assigned to the speaker via a cable connecting the 3.5mm sockets on both products. **If this cable is not fitted, the speaker will only operate in monopole mode.** On the CT8 XO is a switch used to select the mode. In the monopole position, this switch may be overridden by a 12V trigger signal from the surround processor. Some surround processors can recognise the type of programme being played from a code on the disc and allow you to assign a 12V trigger to this code. Some other processors allow you to assign a 12V trigger to the input selection and you may, for example, use a different disc player for audio and movies and set the trigger accordingly. In both these cases, you may choose whichever type of operation best suits the conditions of the listening room, the size of audience and the type of programme being played. Indeed, you may even change the characteristic for different types of programme and, as the total energy into the room is the same in both modes, no recalibration of the installation is necessary when switching between them.

The two bass drivers operate in both modes. In monopole mode, they cross over to the midrange and tweeter drive units on the front face and the speaker is acoustically similar to the CT8 LR, but without the swivelling head. In dipole mode, the bass drivers cross over to the six side-firing drivers. The drive units on opposing sides are connected out of phase with one another, which creates a wedge-shaped null zone, approximately 60° wide, at right angles to the wall. If the listeners sit within this zone, they become less aware of the location of the speakers and hear more reflected sound; hence the diffuse nature of the sound field. (figure 5)

Figure 5

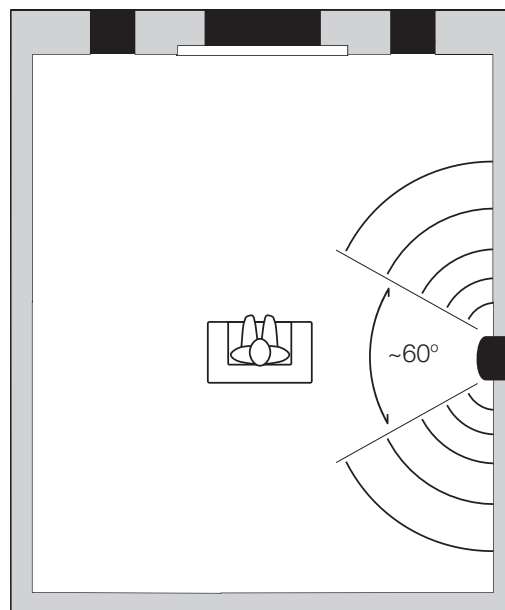

For optimum performance, it is important that the speakers are firmly and securely mounted. All the speakers may be mounted directly at floor level, but, as mentioned above, it can be beneficial to raise the position of the surround speakers and, if the screen is high, it may also be beneficial to do the same with the front speakers. In that case, the supporting structure for the speakers should be substantial. If constructed of wooden studding, the framework should be arranged to be directly beneath the feet of the speaker. (figure 6)

Figure 6

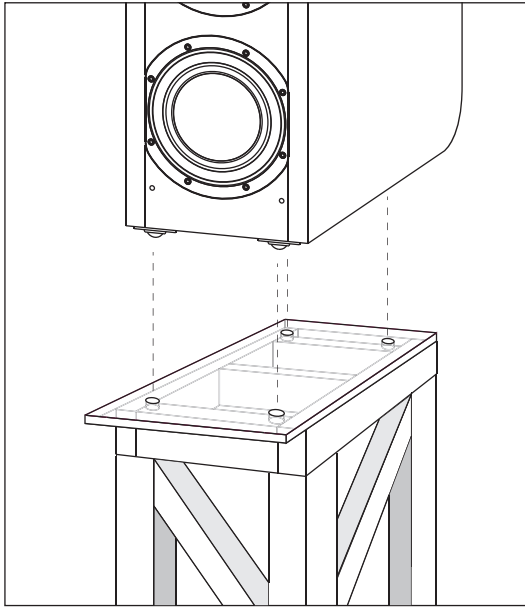

All the speakers are equipped with roller glides on the base panel. These allow the speakers to be easily pushed into place in custom furniture. In order to position the speakers accurately, we suggest you create circular recesses 15mm (5/8 in) diameter in the support surface to locate the glides.



To avoid rocking when the speakers are in position, it is important that these recesses are accurately positioned and a foot-positioning template is supplied for this purpose.

The shaded area at the front of the template is to allow clearance for the movement of the bass cones. For the CT8 DS, the side-firing drive units require free acoustic access into the listening room, indicated by the shaded area of the template extending round the sides. The CT8 DS will normally have the front half of the cabinet protruding clear into the room. It may, however, be built in to a false pillar, but this must be acoustically transparent at the sides, as well as the front, as indicated by the shaded area.

If the speakers are to be inset in a false wall, a front template is provided for guidance in cutting the aperture. The template is the same size as the speaker, so remember to leave some clearance. The height of the template includes the roller glides.

Figure 7

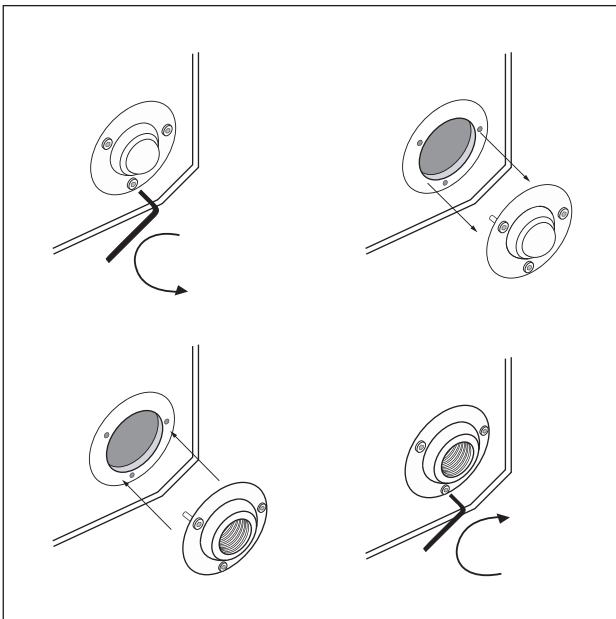

If the speakers are to be mounted in custom furniture, you should also ensure that it is substantially built and not prone to induced vibration. It should be braced where necessary and it may be beneficial to glue bituminous damping pads, similar to those used in motor vehicles, to large unsupported panels. Such pads need to be thicker on wood than metal and a minimum of 6mm (1/4 in) should be used.

If it is desired to remove the roller glides, use the Torx® key supplied with the speaker to remove the retaining screws.

An optional, spike foot kit is also available (Part No FP22359). The kit contains 4 heavy-duty feet that have 40mm (1.6 in) of vertical adjustment, allowing tilt up to 8° if desired. This tilt is in addition to that offered by the adjustable head unit of the CT8 LR and CT8 CC.

The feet are reversible, having a spike for carpets on one end and a rubber pad for vulnerable surfaces on the other. Fitting is most easily accomplished during unpacking, when the underside of the speaker is exposed. (figure 7)



Note that if the optional feet are fitted, or if the speaker is tilted, appropriate allowance over and above that allowed for in the template must be made when cutting an aperture in the wall.

The threaded bosses that hold the feet have a large conical shape on one side of the flange. For maximum height, fit the bosses with the conical shape towards the floor. (figure 8) For minimum height, have them pointing into the speaker. (figure 9)

Screw in the feet close to where you think the final adjustment will be, with the spikes or the rubber ends outermost as appropriate to the floor surface. If you do not intend to tilt the speakers, orient the bosses with the cones inwards and leave just enough thread exposed to fit the locking rings. Fit, but do not tighten the locking rings.

Stand the speaker upright and adjust the feet using the metal bar provided to give the amount of tilt required and to take up any rocking. (figure 10)

Finally, tighten the locking ring against the boss, again using the metal bar. (figure 11)

The tweeter drive units are fitted with a protective clear plastic cover on delivery. This is to avoid the danger of damaging the dome when installing the speakers. Once installed, the protection cover should be removed by simply pulling it away from the speaker.

Figure 8

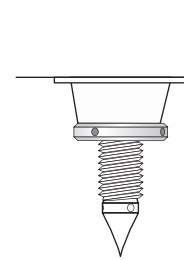

Figure 9

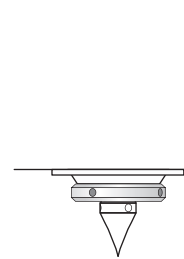

Figure 10

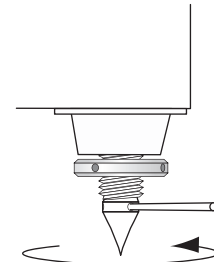
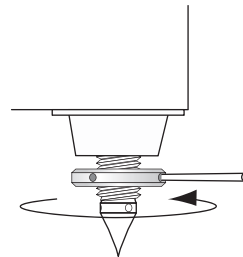

Figure 11



Installation into drywall only. (figure 12)

So that it can be sunk into a standard drywall up to the level of the side-firing drivers, the CT8 DS has a relatively shallow cabinet for its height and is front heavy. To maintain stability, it is equipped with a bracket that enables the rear of the cabinet to be anchored either to a wall surface or the internal studding of a drywall.

In existing construction:
Use a stud finding tool to locate the position of the vertical studs and ensure that the speaker is positioned between them.

If the speaker is to be mounted above floor level, cut into the drywall panel to expose the stud frame sufficiently to allow the insertion of a cross-brace at the appropriate height to support the speaker.



Safety Warning!

Ensure the cross-brace is level and fitted strongly enough to take the substantial weight of the speaker. The speaker can be supported by the cross-brace and the retaining bracket alone if desired, or a more complex support structure may be constructed, for example to hide the underside of the cabinet.

Using the front aspect template provided, mark round the outline at the desired position of the speaker. Allow a little for clearance.

If mounting the speaker at floor level, allow extra height if there is a horizontal stud at floor level.

Cut out the aperture for the speaker

Using the front aspect template provided, mark the centre line of the retaining bracket on the inside surfaces of the two vertical studs either side of the speaker position.

Screw the two angle brackets (A) to the inside face of the vertical struts.

Attach the wall bracket (C) to the angle brackets (A) using machine screws (D) and trapping the stud plate (B) in position.

Patch the drywall as necessary.

Figure 12

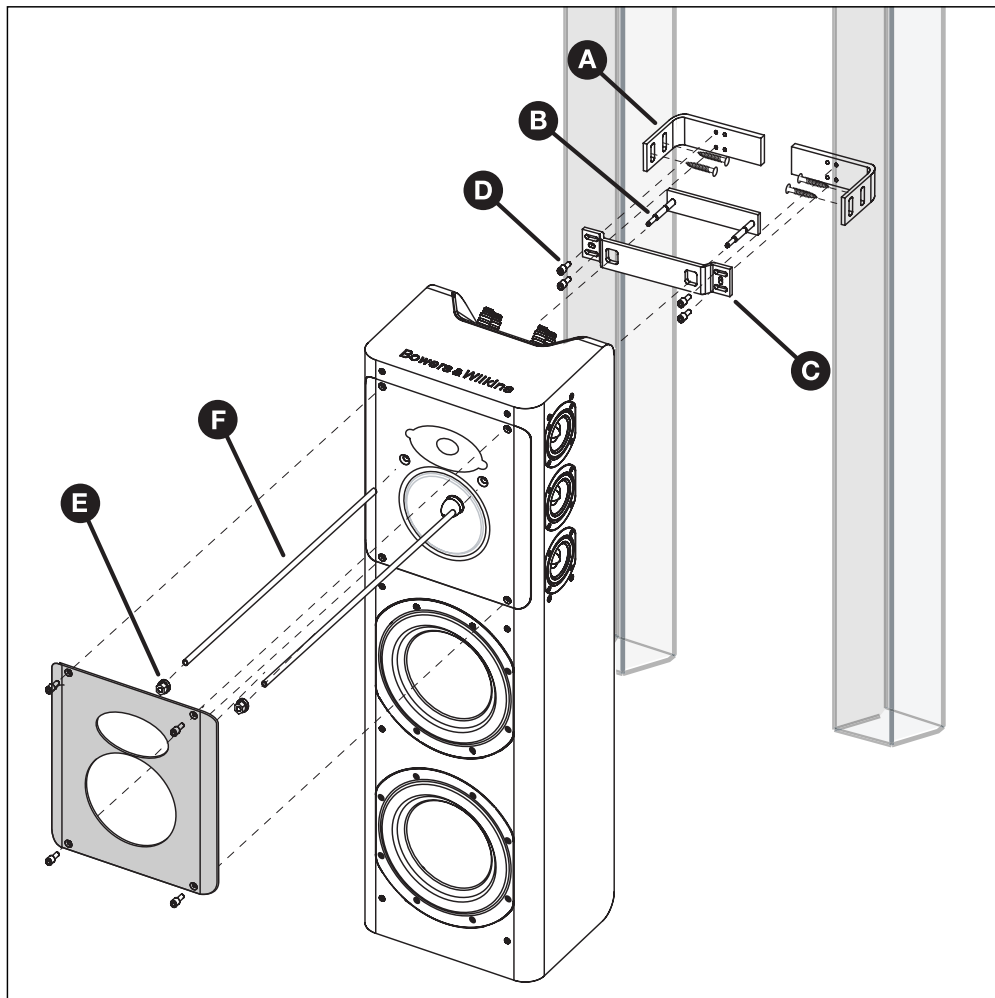

Installation to wall surface only. (figure 13)

Using the front aspect template provided, mark the centre line of the retaining bracket on the wall.

The two angle brackets (figure 12 - A) from the kit are not required.

Offer the wall bracket (C) to the wall and mark the screw positions at each end.

Drill and plug the wall to take screws in the range 5mm - 6mm (No.10 to No.12)

Screw the wall bracket to the wall, trapping the stud plate (B) in position.

Figure 13

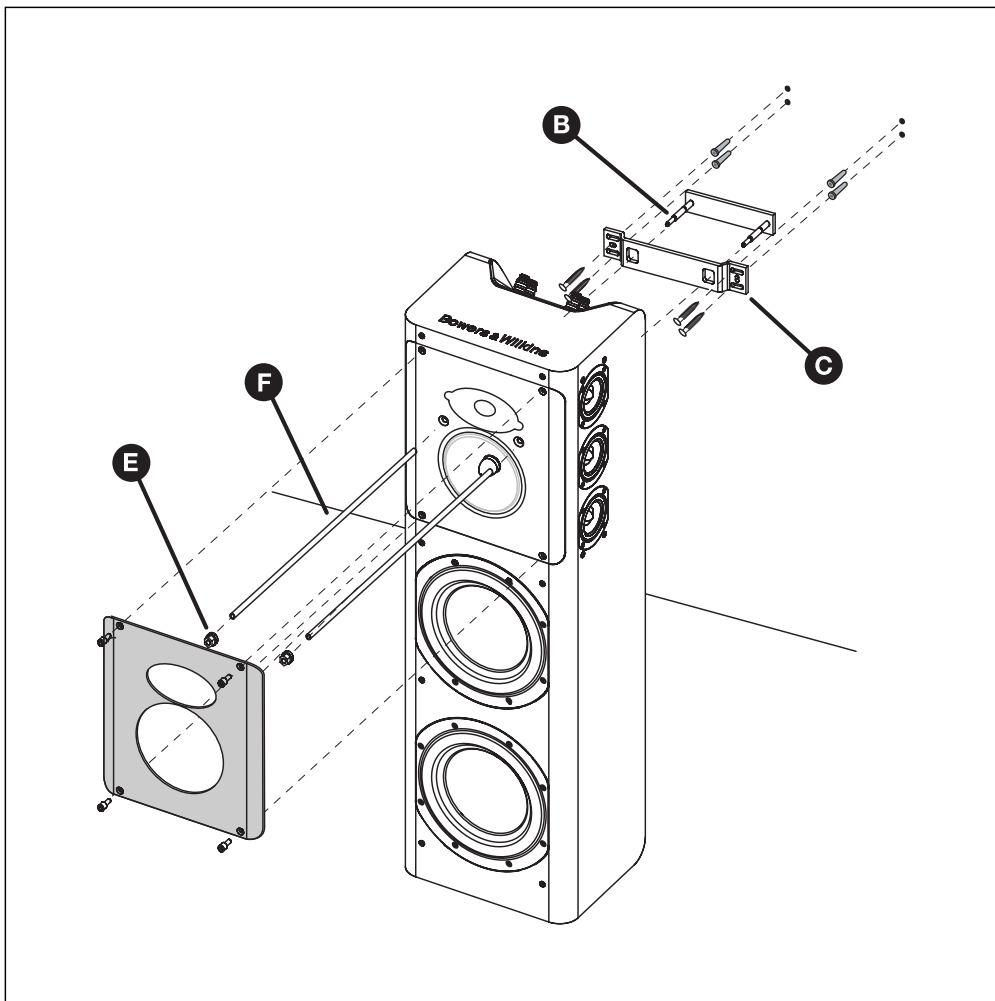

...continue for all cases

Connect the signal and trigger cables to the speakers.

Using the allen key provided, remove the aluminium facing plate on the front of the speaker, taking care that the tweeter protection cover remains in position.

Fit the guide tubes (F) into the two through holes.

Offer the speaker into position, ensuring that the guide tubes (F) locate over the studs of the bracket (B).

When the speaker is fully in position hard against the wall bracket, withdraw the guide tubes.

Using a 1/4 inch socket drive with extension and the 13mm socket provided, fit the two flanged nuts (E) onto the threaded studs and tighten. If the socket drive does not have a nut retaining feature, we recommend the use of a small piece of Bostik® Blu-Tack® or similar reusable adhesive to prevent the nut falling out of the drive during this operation.

Replace the facing plate on the front of the speaker and remove the tweeter protection cover.

If the speaker is mounted on the floor and recessed into a drywall having a horizontal stud member on the floor surface, the height difference may be taken up by fitting the optional spike feet in place of the two front roller glides (figure 14). Only one Spike foot kit will be required for each pair of CT8 DS.

Figure 14

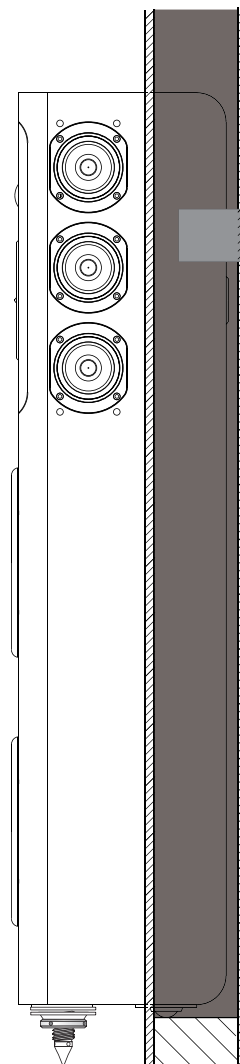

Connecting the System

The Speakers

All the speakers are provided with a comprehensive choice of connection methods. Binding posts accommodate 6mm (1/4 in) or 8mm (5/16 in) spades, 4mm banana plugs and bare wire ends and a Neutrik® Speakon® socket provides a professional industry standard multiway connection that makes it easy to make a connection in confined spaces, especially when it is sometimes difficult to see what you are doing.

For all models except the subwoofer CT8 SW, there are two input channels, one for bass and one for midrange/tweeter, requiring two channels of power amplification. In all cases, ensure that the positive terminal of the speaker is connected to the corresponding positive output connector of the power amplifier. Failure to observe this will result in impaired tonal balance and imaging. Figure 15 shows a typical connection method using binding posts and figure 16 (a & b) the wiring convention for the Neutrik® Speakon® plug.

CT8 DS Only

In addition to the audio signal connections, the CT8 DS terminal panel has a 3.5mm **stereo** jack socket (figure 17) to input two 12V trigger signals from its CT8 XO unit. Use a **stereo** coaxial cable terminated at each end by a 3.5mm stereo jack plug to connect to the complementary output socket (TRIGGER OUT) at the rear of the CT8 XO.

Figure 15

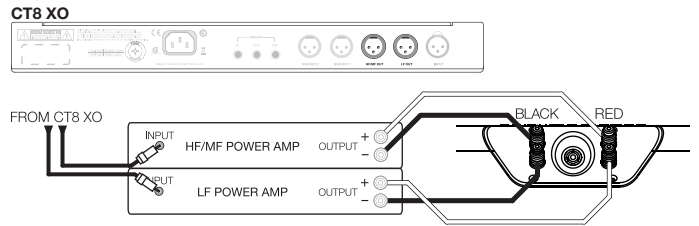

Figure 16a

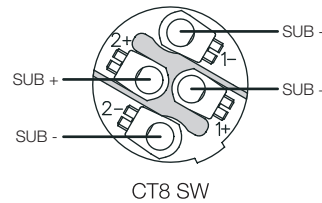

Figure 16b

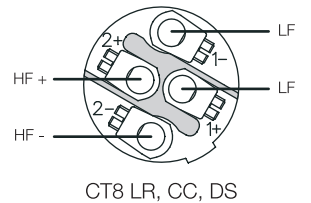
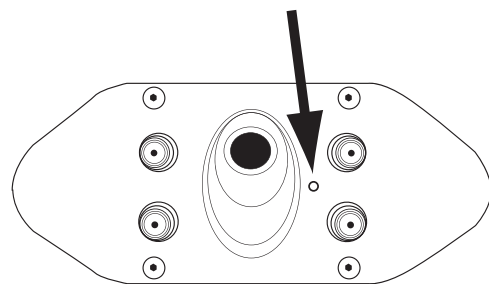

Figure 17



The CT8 XO Mk2 Crossover/Equaliser

The CT8 XO is designed for 19-in rack mounting. If housed in an enclosed structure, proper ventilation must be supplied as stated in the in the safety instructions.

The CT8 XO is connected between the surround processor and the power amplifiers. The CT8 XO signal input and output connections are made through balanced XLR connectors.

The wiring convention for XLR connectors is:

- Pin 1: Ground
- Pin 2: Live (+)
- Pin 3: Return (-)

If 12V trigger switching of the dispersion mode (monopole/dipole) of the CT8 DS surround speakers is required, the assigned 12V trigger output from the surround processor is connected to the 12V TRIGGER IN of one of the CT8 XO units assigned to a CT8 DS. The other CT8 XO trigger inputs are connected daisy chain fashion from the TRIGGER LOOP socket of one to the TRIGGER IN of the next. The TRIGGER OUT sockets are connected to the relevant CT8 DS speakers. The TRIGGER IN and TRIGGER LOOP sockets are **mono** 3.5mm jacks with the positive (12V) wire connected to the tip of the plug, whereas the TRIGGER OUT socket is a **stereo** 3.5mm jack on both the CT8 XO and CT8 DS loudspeaker.

Figure 18 shows the wiring diagram of a typical 5.1 CT800 system having two CT8 SW speakers, one assigned to each of the front left and right channels.

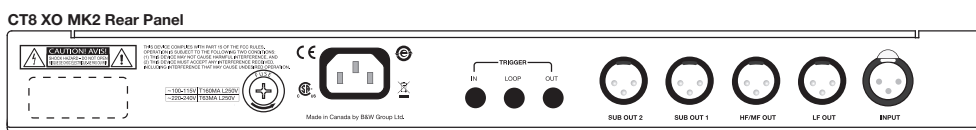
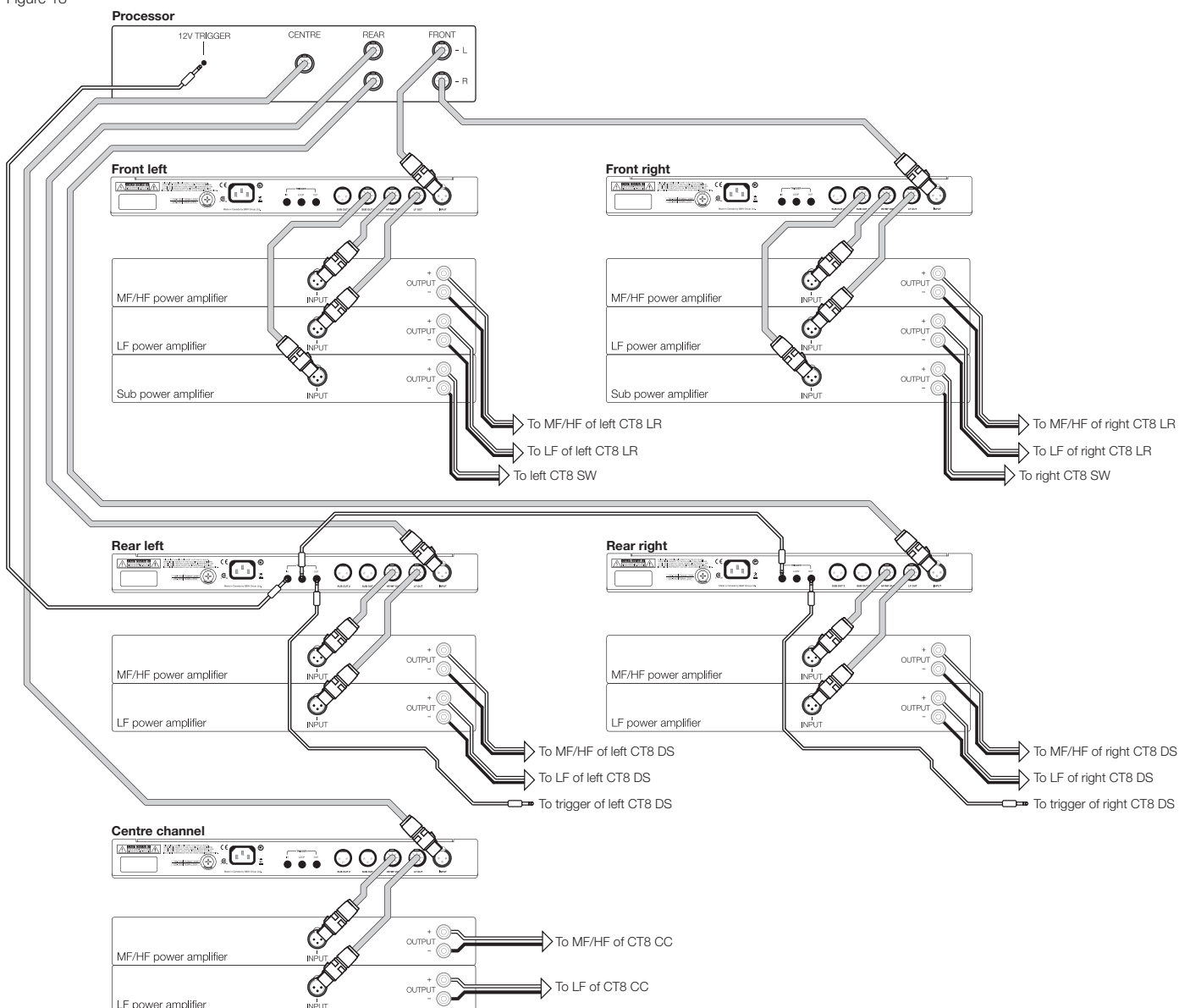

Figure 18



Description of Controls

The unit features a comprehensive set of controls to tune the performance of each speaker according to the conditions of use. The response may be shaped by a combination of three parametric equalisers, each having a switchable range of +3dB, -3dB and -6dB, and low- and high-frequency contour controls, the effects of which are illustrated in figure 19. Selection of the subwoofer low-pass filter frequency also provides some response adjustment. In addition, level controls are provided to compensate for any differences in gain between both the subwoofer and LF power amplifiers compared to the MF/HF power amplifier.

To access the front of the unit, remove the decorative face plate by removing the Philips screws at either end.

Refer to figure 20 for the layout of the inputs and controls, which have the following functions:

| | | |
|-----|--------------------------------|--|
| S1 | Input switch | To switch between test and normal inputs. |
| T1 | Test input socket | To connect external signal generator. |
| S2 | Speaker select switch | To switch between front, centre and surround channels. |
| S3 | Dipole select switch | To select appropriate positive lobe orientation for left and right surround channels in dipole mode. |
| C1 | High-frequency contour control | Selects HF eq options. ± 4 dB. See figure 19, bottom graph. |
| C2 | Low-frequency contour control | Selects LF eq options. ± 6 dB. See figure 19, top graph. |
| S4 | Subwoofer selection switch | None, one or two. |
| S5 | Subwoofer filter switch | Selects subwoofer filter frequency. 40Hz, 50Hz, 60Hz. |
| S6 | LF/Subwoofer fixed gain | Enables or disables LF and subwoofer gain adjustment. |
| C3 | LF Gain | Adjusts LF gain. |
| C4 | Subwoofer gain | Adjusts subwoofer gain. |
| S7 | Parametric filter | Engages number of parametric filters in circuit. None, one, two or three. |
| S8 | P1 Gain | Selects gain of parametric filter 1. -6dB, -3dB, +3dB. |
| C5 | P1 Q | Adjusts Q of parametric filter 1 0.3 to 4. |
| C6 | P1 Freq | Adjusts frequency of parametric filter 1. 25Hz to 500Hz. |
| S9 | P2 Gain | Selects gain of parametric filter 2. -6dB, -3dB, +3dB. |
| C7 | P2 Q | Adjusts Q of parametric filter 2 0.3 to 4. |
| C8 | P2 Freq | Adjusts frequency of parametric filter 2. 25Hz to 500Hz. |
| S10 | P3 Gain | Selects gain of parametric filter 3. -6dB, -3dB, +3dB. |
| C9 | P3 Q | Adjusts Q of parametric filter 3 0.3 to 4. |
| C10 | P3 Freq | Adjusts frequency of parametric filter 3. 25Hz to 500Hz. |

Figure 19

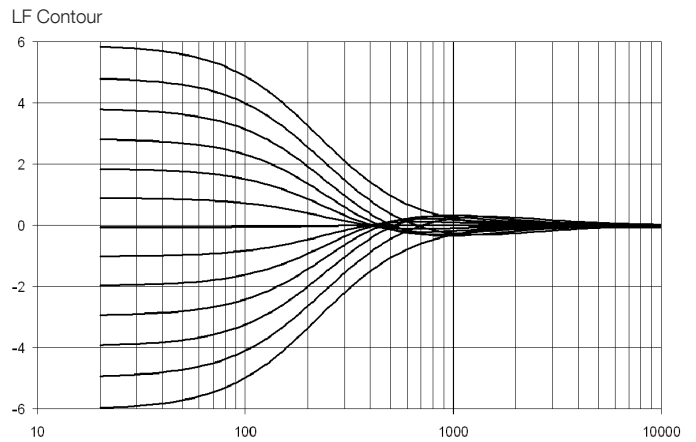

HF Contour

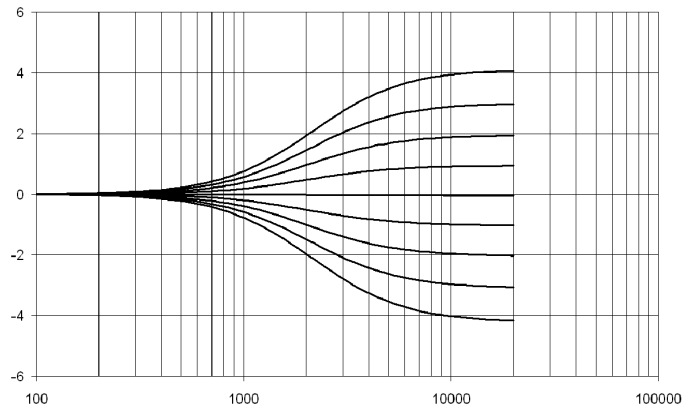

Figure 21

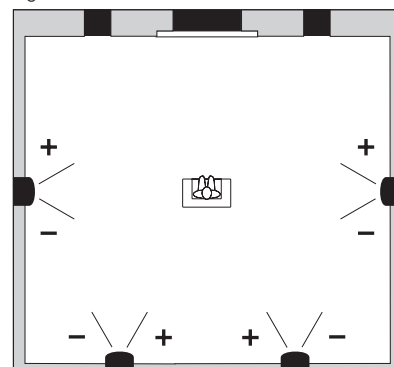
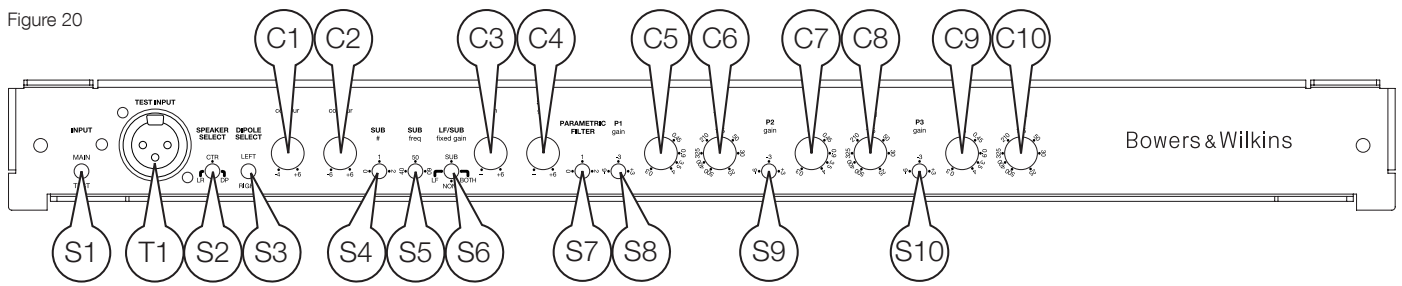

Figure 20



Equipment Required

- AC voltmeter
- Signal generator capable of outputting a sine wave up to 2V RMS
- Small and medium size flat bladed screwdrivers to select the switch positions and adjust the rotary controls of the CT800 XO.

And to adjust the equalisers to optimise the in-room response:

- Laptop PC with WinMLS 2004 (or later version) software installed
- External sound card
- Measuring microphone

WinMLS may be purchased directly from the software supplier, in which case it should be WinMLS 2004 or later and be to level 3 license. It should also include the specially created “B&W CT800” measurement module. Early versions of the software did not include this module, but the latest version may be downloaded from www.winmls.com.

However, a special package that includes a suitable microphone, USB sound card and a cut-down version of the software that includes everything required for tuning a CT800 system may be obtained directly from B&W. Contact your country distributor for details.

These illustrations on the following pages refer to the B&W version of the software. The standard version will differ slightly.

Configuring the CT8 XO to the speaker

Set switch S2 to select the type of speaker assigned to the CT8 XO. If the speaker assigned is a surround speaker, set switch S3 to select left or right dipoles as appropriate to each speaker’s position in the room (figure 21). If the surround speakers are to be permanently in monopole mode, the position of switch S3 is immaterial.

Set switch S4 to select the number of subwoofers connected to the CT8 XO.

Set switch S5 to select the subwoofer filter frequency. Set the S5 initially to 50Hz. The 40Hz or 60Hz options may be selected if appropriate when fine tuning the installation.

Configure the unit to the gain of each power amplifier

During this process, the parametric equalisers should be bypassed by setting switch S7 to “None” and the LF and HF contour controls, C1 and C2, set to zero.

Setting the LF gain

Disconnect the speakers from the power amplifiers.

Connect the MF/HF power amplifier to the LF output of the unit.

Set the output level of the oscillator to zero and connect it to the test input socket T1. Select the test input by switching the input switch S1 to “Test”.

Set the oscillator frequency to 100Hz.

Enable LF gain adjustment by setting switch S6 to “LF”.

Connect the AC voltmeter to the output terminals of the MF/HF amplifier.

Raise the output level of the oscillator until the meter reads 2 volts.

Substitute the LF power amplifier for the MF/HF power amplifier. Do not alter the output setting of the oscillator.

Adjust the LF gain control (C3) until the meter again reads 2 volts.

Setting the subwoofer gain

Disconnect the speakers from the power amplifiers.

Connect the MF/HF power amplifier to the Subwoofer output of the unit.

Set the output level of the oscillator to zero and connect it to the test input socket T1. Select the test input by switching the input switch S1 to “Test”.

Set the oscillator frequency to 25Hz.

Enable subwoofer gain adjustment by setting switch S6 to “Sub”.

Connect the AC voltmeter to the output terminals of the MF/HF amplifier.

Raise the output level of the oscillator until the meter reads 2 volts.

Substitute the Sub power amplifier for the MF/HF power amplifier. Do not alter the output setting of the oscillator.

Adjust the Sub gain control (C4) until the meter again reads 2 volts.

Configure the Equalisers

Sensible correction of the in-room response requires the ability to measure the acoustic frequency response of each speaker individually. The measurement microphone does not need to be expensive and suitable electret microphones are widely available. If the appropriate measuring equipment is not available, we recommend that the parametric filters be bypassed by setting switch S7 to 0. Setting of the low- and high-frequency contour controls may be attempted by ear to the user's preference.

Correcting for room resonances requires thought, skill and patience. It is not sensible to attempt to fully equalise response dips, as this may lead to system overload. Fortunately, dips are less objectionable than peaks. For this reason, each parametric filter allows just 3dB of boost, but 6dB of cut.

It is also not advisable to make corrections to a single position measurement. The response of the speaker/room combination can differ considerably throughout the room and it is all too easy to worsen the response in one position whilst making it better in another. An average of several measurements taken at different positions throughout the room should ideally be used to ensure an overall improvement in all listener positions.

The Method

We suggest taking measurements at each seat position and at several points outside the immediate listening area. Point the microphone towards the speaker being measured.

The resonances change with height. Often seats will be at the same level, so put the microphone at a typical ear height. If the home theatre room is like a mini cinema with regular rows of raked seating, measure at each seat at the likely ear height. Do not hand hold the microphone during measurements. Use a tripod or other means of holding it still. It is advisable to make the last measuring position **n** (the one used for subsequent equalised measurements) the primary listening position.

Procedure

To avoid errors from airborne background noise and electrical interference, switch off all sources in the room such as air conditioning, refrigerators etc.

Laptop computer settings:

Run the laptop from its battery and disconnect its transformer power supply when taking measurements. This will prevent noise being generated by electrical grounding mismatches between the laptop, sound card and CT8 XO. Make sure the battery is fully charged before starting the measuring procedure.

Open the "Sounds and Audio Devices" window in "Control Panel". Click on the "Sounds" tab and select the "No Sound" option in the "Sound Scheme" drop-down menu.

Click on the "Volume" button in the "Sound Playback" section and make sure the Microphone "Mute" box is checked to prevent feedback.

Click on the "Audio" tab and then on the "Volume" button in the "Sound Recording" section. Set the volume slider to maximum and make sure the "Select" box is checked.

Select the test input by switching the input switch S1 to "Test".

Setting switch S7 to "None" to disable the parametric equalisers and set the LF and HF contour controls, C1 and C2, set to zero.

Connect the output of the sound card to the front test input socket of the CT8 XO and the microphone to the input of the sound card.

Open WinMLS2004

From the menu, select **Setup...Load...** and load the setup called "B&W CT800" from the "Sound System" folder.

Click the  button to open the "Volume and Input Levels" window.

Figure 22

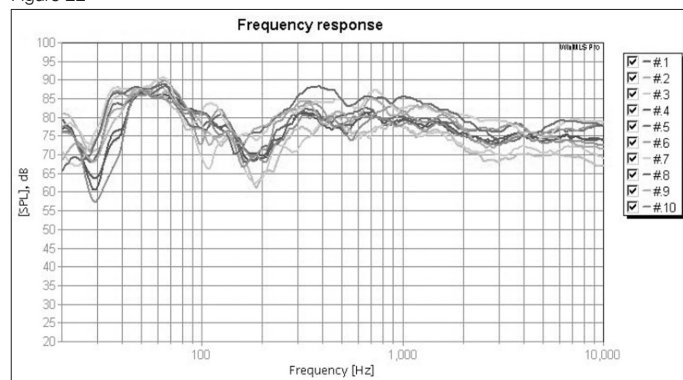

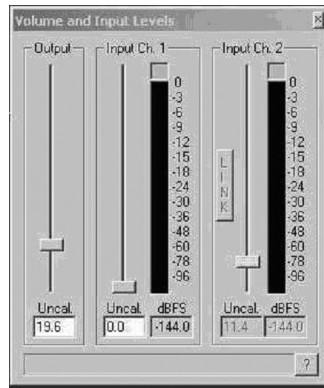

Figure 23

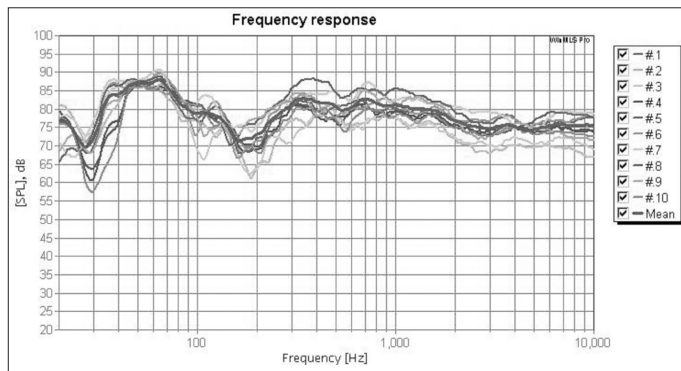

Figure 24

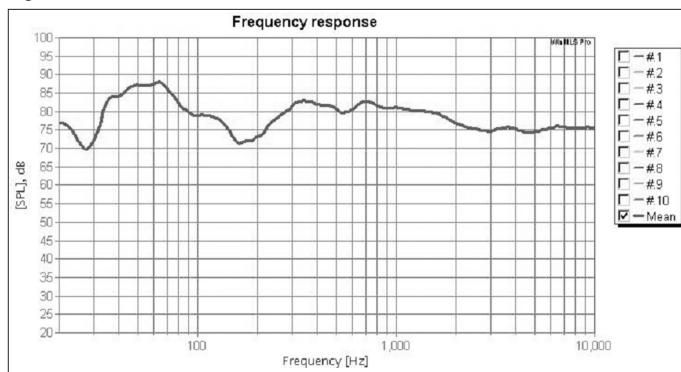
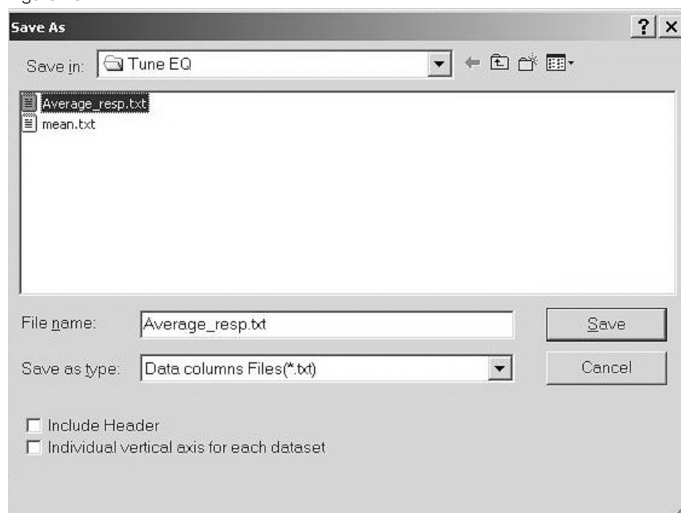



Figure 25



Place the microphone at the chosen measurement position that is closest to the speaker under test (where it will measure the highest sound pressure level). Set the “Input Ch.1” slider to maximum.

Set the “Output” slider to zero and switch on the test signal by clicking the  button. Increase the output level until the “Input Ch.1” level meter just goes into the red zone. Decrease the “Input Ch.1” level until the signal peaks between the -6dB and -3dB marks.

Close the “Volume and Input Levels” window and click  the button to switch off the test signal.

Make sure **Plot...Overlay** is checked to show the frequency response screen and enable several responses to be viewed simultaneously.

Press the F7 key to bring up the Measurement Settings window. In the “Levels” box, set the sine sweep to -40dB FS (full scale).

Perform a number of measurements in different positions by clicking the  button (or pressing the F2 key). Make the last measurement you take close to the centre of the listening area and leave the microphone exactly in that position for subsequent measurements. Since **Plot...Overlay** is checked, the curves will be plotted on top of each other and, when finished, there will be n curves displayed.

In the example shown in figure 22, $n = 10$.

Click the  button to display the mean value on top of all the plotted curves. The average room response is then calculated (figure 23). **This is the response we want to equalise.**

Un-tick all the plots except the mean response. (figure 24)

Press **CTRL+ E** to save this mean result in the “Tune EQ” folder (if this folder doesn’t exist, create it in C:\Program Files\WinMLS2004\Set EQ). Then click **Save** and name the file, for example, Average_resp.txt (figure 25)

To set this curve as a multiplier, press the F5 key. In this dialog box, select the file you just saved (**Average_resp**) and, under 'Compensation of Level', check the 'Tune EQ (multiply)' box as shown (figure 26). This curve is now the reference and all subsequent measurements will be multiplied by this response.

Click OK. The graphs will change, but ignore these changes.

We now need to set division by the measurement performed in this last position with no equalisation (**R_n**).

Press **Ctrl + F** and make sure this last measurement is selected as shown in figure 27 (in this example #10 was the last measurement position and that is therefore set as reference).

Click **OK**.

The graphs will change, but ignore these changes.

When we now perform another measurement with the equalisation applied (**R_{neq}**), the software will calculate the quantity:

$$R_{meq} = \frac{R_{neq} \cdot R_m}{R_n}$$

In our case the original measurement at position #10 is **R_n**.

Now it is time to clean up the display. Make sure the following button is turned off:



To remove the measurements we used to make the reference, click the erase button  and select the settings shown in figure 28 (this will remove all the curves in the plot and remove the measurements from memory).

There will now be no plots showing on the screen. Make sure the

Overlay button  is in the down state.

Click  (or press the F2 key) to re-measure the response at the last position. This time on the screen, you will be presented with the mean response.

Examine this mean response and consider the optimum target to aim for. A flat in-room response is not desirable. Studies show that a more suitable target is a response that is flat up to 100Hz and then falling uniformly by a total of 6dB by 10kHz.

Tune the parametric filters first before using the low- and high-frequency contour controls.

There are three filters, each having adjustable centre frequency, gain and Q. Aim to suppress peaks first. Only if there are fewer than three significant peaks should you consider filling in dips.

Figure 26

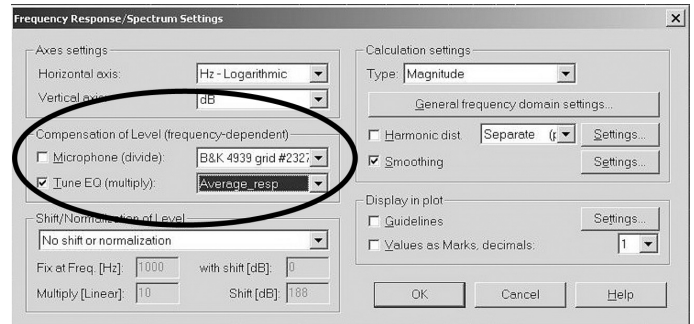

Figure 27

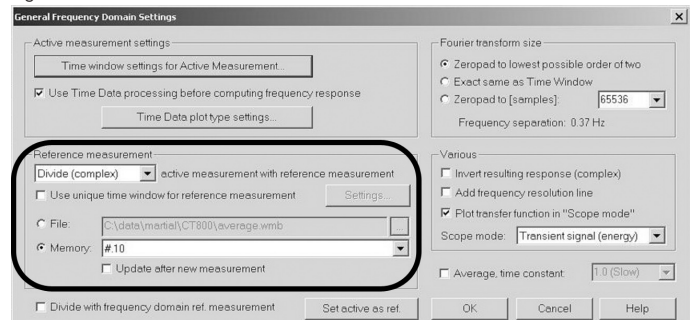
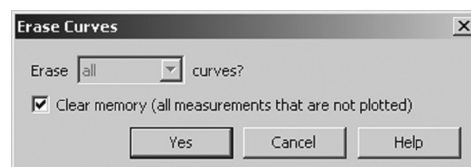

Figure 28



Specify the number of parametric filters required by selecting "1", "2" or "3" on switch S7.

The markings on the filter control dials are approximate and for guidance only.

Set the individual filter gain controls (S8, S9 & S10) to -6dB.
Set the individual filter Q controls (C5, C7 & C9) to 4.

This enables the centre frequency response of the filters to be seen.

Set the individual filter frequency controls (C6, C8 & C10) initially to 25Hz. This keeps the filters away from the frequency range of interest until they are tuned one at a time to compensate the frequency response.

NOTE:

The P1, P2 and P3 frequency controls work counter-clockwise to allow for ease of setting.

Turn the filter frequency controls (C6, C8 & C10) to the centre frequencies of the peaks or dips to be equalised. This is an approximate initial setting.

Take repeated frequency response measurements to see the effects of the adjustments you are about to make. Every now and then you may wish to discard plots and this may be done by unchecking those you do not need on the plot list to the right of the screen.

Adjust the filter centre frequencies until the measured dips in the response line up accurately with the centres of the peaks or dips originally in the response.

Adjust the filter gain switches (S8, S9 & S10) so that the response at the centre frequency of each filter is at the target level (the desired smoothed level).

Lower the filter Q controls (C5, C7 & C9) to broaden the range of the filters until the response is as smooth as possible.

The controls are to some extent interactive and it may be worthwhile going round the loop of checking the control settings a second time.

Adjust the LF and HF contour controls, C1 and C2, as appropriate.

Additional low frequency response adjustment may be achieved by altering the subwoofer gain (C4) and filter frequency (S5). Additional low/mid frequency adjustment may be achieved by altering the LF gain (C3).

If you need to equalise another speaker, you must reload the CT800 setup within WinMLS and repeat the above process.

Ancillary Equipment

Speakers of this ability deserve signals of the highest quality. Choose your electronic equipment and interconnecting cables with care. We can give guidance on what to look for when choosing ancillary equipment, but cannot recommend specific items. The standards of such products are improving all the time and your dealer will be able to demonstrate a variety of suitable up-to-date products.

In the specification we recommend a range of amplifier powers. The higher figure is defined by the power handling capability of the speaker. When calculating the power handling, it is assumed that the amplifier is not run into clipping, which distorts the frequency power spectrum of the signal, and that the signal is normal programme material. Test tones from oscillators and the like are not applicable. The lower figure is the minimum we consider necessary to achieve reasonable listening levels without audible distortion in the smaller room (less than 60 m³ or 2000 cu ft). The higher the power you use, the less likely you are to experience amplifier clipping.

You can often tell how good an amplifier is at driving complex speaker loads by looking at its power rating into both 4Ω and 8Ω loads. The nearer the ratio is to 2:1 the better, as it indicates a good current capability.

In order to reduce the effect the cable has on the frequency response of the speaker to inaudible levels, the impedance of the cable at all frequencies (measuring both positive and negative conductors in series) should be kept as low as possible and certainly below 0.1Ω. At low frequencies, the DC resistance of the cable is the dominant factor and you should choose a gauge of wire sufficient to achieve the impedance requirements over the length of cable you need to use. At mid and high frequencies the inductive component of the impedance can dominate the DC resistance. This and other properties influenced by the detailed construction of the cable become important.

Running In

The performance of the speakers will change subtly during the initial listening period. If they have been stored in a cold environment, the damping compounds and suspension materials will take some time to recover their correct mechanical properties. The drive unit suspensions will also loosen up during the first hours of use. The time taken for the speakers to achieve their intended performance will vary depending on previous storage conditions and how they are used. As a guide, allow up to a week for the temperature effects to stabilise and 15 hours of average use for the mechanical parts to attain their intended design characteristics.

However, longer run-in periods (as long as a month) have been reported and there is evidence to suggest that this has little to do with the speaker changing and more to do with the listener getting used to a new sound. It is especially so with highly revealing speakers such as these, where there may be a significant increase in the amount of detail portrayed compared to what the listener has previously been used to; the sound may at first appear too “up front” and perhaps a little hard. After an extended period of time, the sound will seem to mellow, but without losing clarity and detail.

Aftercare



The speaker cabinet surfaces and the casing of the CT8 XO usually only require dusting. If you wish to use an aerosol cleaner, remove any speaker grilles first by gripping round the edges and gently pulling them away from the cabinet. Spray onto the cleaning cloth, not directly onto the cabinet. The grille fabric may be cleaned with a normal clothes brush whilst the grille is detached from the cabinet.

When replacing grilles, ensure that the pegs are correctly aligned with the receptacles in the cabinet before pushing into place.

Avoid touching the drive unit diaphragms, especially the tweeter, as damage may result.

Specifications

| Model | CT8 LR | CT8 CC |
|--|--|--|
| |  |  |
| Description | 3-way closed-box system | 3-way closed-box system |
| Drive Units | 1x Ø32mm (1¼ in) metal dome high-frequency 1x Ø150mm (6 in) woven Kevlar® cone FST™ midrange 2x Ø250mm (10 in) Rohacell® cone bass | 1x Ø32mm (1¼ in) metal dome high-frequency 1x Ø150mm (6 in) woven Kevlar® cone FST™ midrange 2x Ø250mm (10 in) Rohacell® cone bass |
| Frequency Range | -6dB at 23Hz and 40kHz | -6dB at 23Hz and 40kHz |
| Frequency Response | 29Hz - 24kHz ±3dB on reference axis | 29Hz - 24kHz ±3dB on reference axis |
| Dispersion | Within 2dB of reference response Horizontal: over 60° arc Vertical: over 10° arc | Within 2dB of reference response Horizontal: over 60° arc Vertical: over 10° arc |
| Sensitivity | 93dB spl (2.83V, 1m) (mf/hf) | 93dB spl (2.83V, 1m) (mf/hf) |
| Harmonic Distortion | 2nd and 3rd harmonics (90dB, 1m) <1% 45Hz - 20kHz <0.5% 55hZ - 20kHz | 2nd and 3rd harmonics (90dB, 1m) <1% 45Hz - 20kHz <0.5% 55hZ - 20kHz |
| Nominal Impedance | 8Ω (minimum 4Ω) | 8Ω (minimum 4Ω) |
| Crossover Frequency | 300Hz, 4kHz | 300Hz, 4kHz |
| Recommended Amplifier Power | 500W - 1000W into 8Ω on unclipped programme | 500W - 1000W into 8Ω on unclipped programme |
| Max Recommended Cable Impedance | 0.1Ω | 0.1Ω |
| Dimensions | Height: 1100mm (43.3 in) (without spike feet) Width: 325mm (12.8 in) Depth: 550mm (21.65 in) | Height: 325mm (12.8 in) (without spike feet) Width: 1100mm (43.3 in) Depth: 550mm (21.65 in) |
| Weight | 85kg (187 lb) | 85kg (187 lb) |
| Finish | Cabinet: Black | Cabinet: Black |

| Model | CT8 DS | CT8 SW |
|--|--|--|
| |  |  |
| Description | 3-way monopole/2-way dipole selectable closed-box surround system | Closed-box subwoofer |
| Drive Units | 1x Ø32mm (1¼ in) metal dome high-frequency 6x Ø100mm (4 in) midrange/high-frequency 1x Ø150mm (6 in) woven Kevlar® cone FST™ midrange 2x Ø250mm (10 in) Rohacell® cone bass | 1x Ø380mm (15 in) carbon fibre/Rohacell® sandwich cone bass |
| Frequency Range | -6dB at 26Hz and 40kHz (monopole mode) -6dB at 26Hz and 22kHz (dipole mode) | -6dB at 13Hz and 40kHz |
| Frequency Response | 31Hz - 22kHz ±3dB on reference axis (monopole mode) 31Hz - 18kHz ±3dB power averaged over front hemisphere (dipole mode) | 18Hz - 35kHz ±3dB on reference axis |
| Dispersion | Monopole mode: Within 2dB of reference response Horizontal: over 60° arc Vertical: over 10° arc Dipole mode: horizontal figure of eight Effective null zone ±30° (250Hz - 18kHz) | Within 2dB of reference response Horizontal: over 90° arc Vertical: over 90° arc |
| Sensitivity | 93dB spl (2.83V, 1m) (mf/hf) | 90dB spl (2.83V, 1m) (mf/hf) |
| Harmonic Distortion | 2nd and 3rd harmonics (90dB, 1m) <1% 45Hz - 20kHz | 2nd and 3rd harmonics (90dB, 1m) <1% 30Hz - 500Hz <0.5% 45Hz - 300Hz |
| Nominal Impedance | 8Ω (minimum 4Ω) | 8Ω (minimum 4Ω) |
| Crossover Frequency | 300Hz and 4kHz (monopole mode) 300Hz (dipole mode) | 40Hz |
| Recommended Amplifier Power | 500W - 1000W into 8Ω on unclipped programme | 500W - 1000W into 8Ω on unclipped programme |
| Max Recommended Cable Impedance | 0.1Ω | 0.1Ω |
| Dimensions | Height: 1100mm (43.3 in) (without spike feet) Width: 325mm (12.8 in) Depth: 250mm (9.85 in) | Height: 475mm (18.7 in) (without spike feet) Width: 475mm (18.7 in) Depth: 475mm (18.7 in) |
| Weight | 75kg (165 lb) | 35kg (77 lb) |
| Finish | Cabinet: Black | Cabinet: Black |

| | |
|--------------------------------|---|
| Model | CT8 XO Mk 2 |
| |  |
| Description | CT800 system active bass management controller |
| Functions | <ul style="list-style-type: none"> Bass/midrange crossover Subwoofer/bass crossover Low-frequency roll-off alignment High frequency roll-off alignment 3 parametric equalisers Subwoofer in/out Level adjustment for number of subwoofers 12V trigger switching for surround mode |
| Inputs | <ul style="list-style-type: none"> Line In (XLR) 12V trigger (3.5mm jack) |
| Outputs | <ul style="list-style-type: none"> MF/HF Line Out (XLR) LF Line Out (XLR) Subwoofer Line Out (2 x XLR) 12V trigger (3.5mm jack) |
| Rated power consumption | 20W |
| Dimensions | <ul style="list-style-type: none"> Height: 44.5mm (1.75 in) 1U Width: 483mm (19 in) Depth: 155mm (6.1 in) |
| Weight | 3kg (6.6 lb) |
| Finish | <ul style="list-style-type: none"> Front panel: Anodised Aluminium Chassis: Black |

Bowers & Wilkins

B&W Group Ltd
Dale Road
Worthing West Sussex
BN11 2BH England

T +44 (0) 1903 221 800
F +44 (0) 1903 221 801
info@bwgroup.com
www.bowers-wilkins.com

UK Group (UK Sales)
T +44 1903 221 500
E uksales@bwgroup.com

B&W Group North America
T +1 978 664 2870
E marketing@bwgroupusa.com

B&W Group (Asia) Ltd
T +852 2 869 9916
E showroom@bwgroup.hk

Copyright © B&W Group Ltd. E & OE

Kevlar is a registered trademark of DuPont
Rohacell is a registered trademark of Röhm GmbH

Printed in Canada.
Issue 5