

HD30 User Manual





Congratulations, with your new Hegel HD30, our best D/A Converter. All Hegel products are based on a simple philosophy: Add as little as possible. Keep the music signal as close to the original as possible. We always chase lower distortion and lower noise. The music is reproduced as close to the original as possible and is limited only by the quality of the recording. Our aim is to give you the best possible music experience. Our minimalistic Scandinavian design is styled to fit in with any interior. The products shall be easy to operate and shall be manufactured according to the best quality principles.

“After years of relentless demand for a Hegel full-sized DAC, we finally embarked on designing the HD30. It evolved into the most ambitious design project in HEGEL’s 25-year history. HD30 incorporates many ground-breaking technologies, resulting in unparalleled sonic performance. The HD30 features outstanding connectivity, allowing one to connect to virtually any digital source/device with easy control. The HD30 is, without a doubt, HEGEL’s most advanced product to date. In my humble opinion, it’s the finest product ever created by HEGEL.”

A handwritten signature in black ink, appearing to read 'Bent Holter', with a long, sweeping horizontal line extending to the right.

Bent Holter
Founder Hegel Music System

Index

What`s in the box	4
Quickstart	5
General Use	8
Connections	9
Network Configuration	10
Using AirPlay	11
Remote Control	12
Special Functions	13
General Information	14
Additional Information	15

What`s in the box

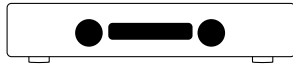

DAC

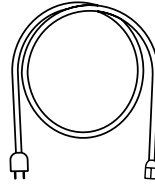

Power Cord

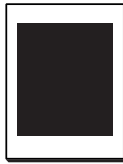

Accessory Box



Remote Control

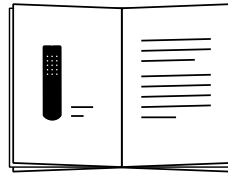

User Manual

Quickstart

1. Connect your speakers / amplifier

Use unbalanced(RCA) or balanced(XLR) cables from HD30 to your speakers or amplifier.

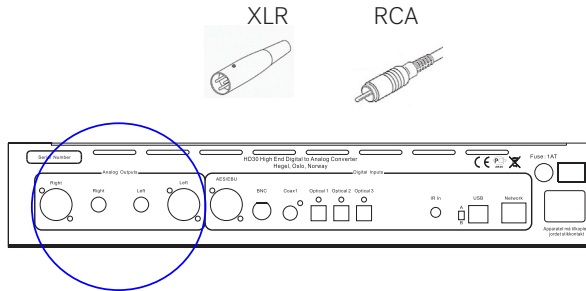

For the best audio experience the distance between the listener and each speaker should be the same.

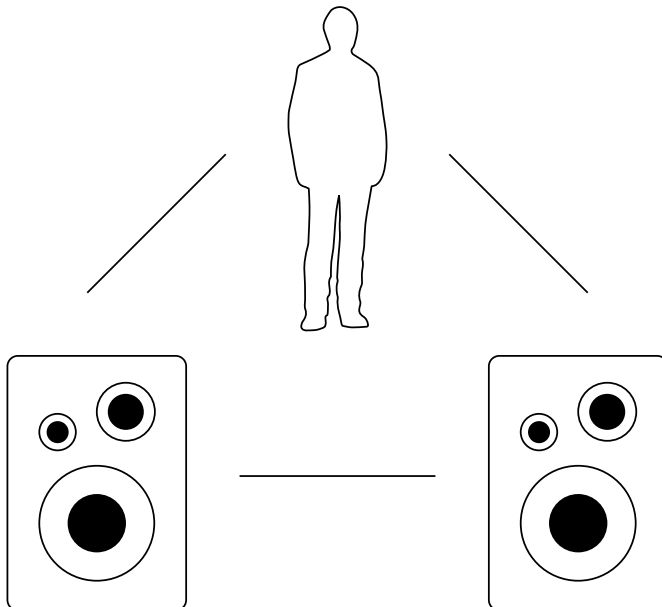

Quickstart

2. Connect a source



BNC Digital

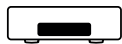

AES/EBU XLR Digital

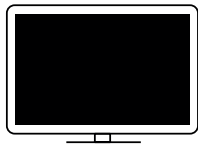

Coaxial Digital

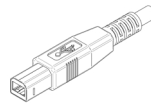

USB Computer

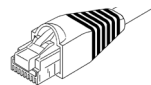

Network streaming

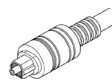

Optical Digital

Quickstart

3. Connect the power cord

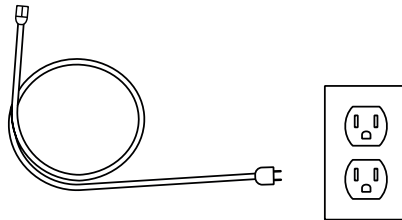
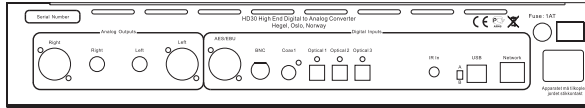

4. Turn on the DAC

Power Switch

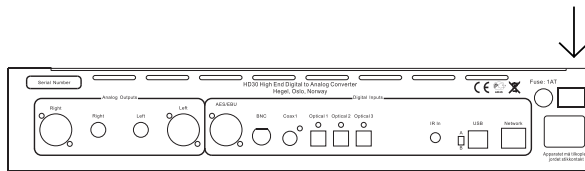

General Use

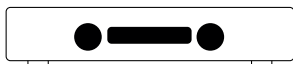

On/Off

The HD30 DAC is switched on and off with the power button, located on the backside of the amplifier. When powered up, the HD30 takes a few seconds to calibrate. During this time, the outputs are muted.

NOTE: When powered up, the outputs are muted and the right hand part of the display flashes for a few seconds, indicating mute. This is normal, and is part of the start-up procedure.

NOTE: When the HD30 has been switched off, wait 30 seconds before powering on again.

Status Indicators

The Hegel HD30 will display the product status.

- If it is connected to a network, a period will light up in the lower right corner of the display
- If there is a network problem, a period will flash in the lower right corner of the display.
- If there is a firmware issue , "Err" + error code will appear in the display.

Source Selector

The input source selector knob is on the left side of the front panel. The three letters indicate the selected source input.

Mute

Pressing the mute button on the Hegel remote control mutes the analog outputs. The volume number flashes to indicate that mute is on. Press the mute button or adjust the volume level to switch mute off.

Volume

The volume control knob is on the right side of the front panel. The volume level is indicated by a number between 0 and 100 on the right side of the display, with 0 being the mute level and 100 being max volume. The volume level is adjusted by turning the volume knob clockwise or counter clockwise, or by using the Hegel remote control. Pressing the Vol+ button after HD30 has been put in volume 100, activates volume bypass. This is displayed as volume 101. When the HD30 is set to volume bypass(101) it will remember this setting, and the HD30 will start up in volume bypass mode. Sampling frequency will appear in the right hand side of the display. Any other volume setting will set the startup volume to 20, when HD30 is turned off.

Display

The left side of the display shows the selected source input, while the volume value is shown on the right side of the display. A flashing volume value indicates the amplifier is in mute mode.

Connections

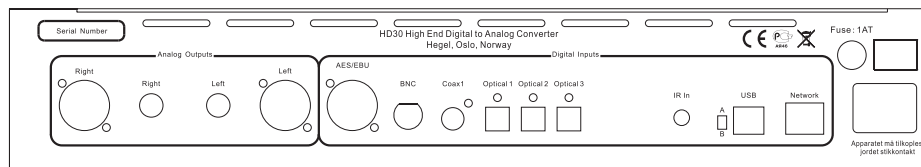

Analog Outputs

- Balanced signal output(XLR) Right
- Unbalanced signal output(RCA) Right
- Unbalanced signal output(RCA) Left
- Balanced signal output(XLR) Left

AC Power Connection

- AC Power connector with fuse holder: 230V/115V/100V AC depending on country.

IR

- Direct IR in – 3.5 mm jack, max 12V
-

Digital Inputs

- AES/EBU
- BNC
- Coax1
- Optical 1
- Optical 2
- Optical 3
- USB Mode selector switch
- Computer USB input

Home network connection (LAN - RJ45)

Always power the DAC off before connecting input/output audio cables and the power cable.

The D/A Converter has two types of analog audio outputs: unbalanced audio signal (RCA/phono) and true balanced audio signal (XLR – pin 2 is positive phase, pin 3 is negative phase and pin 1 is chassis ground).

We recommend using the balanced XLR outputs from the D/A Converter, as this will give the highest level of sound quality.

We recommend using the BNC or Coax1 input for the best performance, this because it has the best impedance and lowest jitter.

Network Configuration

On the Network Configuration page you can setup the Hegel HD30. You can change the name, the IP settings and update the firmware.

To access the setup page on a PC open the network settings, under Media devices the Hegel HD30 will appear.(If the Hegel HD30 does not appear, make sure the network is setup to hand out IP addresses automatically). Then you double click on the Hegel HD30, and the Network Configuration page opens.

To access the setup page on a MAC, open the Safari browser. Under bookmarks you will find the Bonjour tab, and here the Hegel HD30 will appear.

Make sure you have included the Bonjour in the Bookmarks Menu (Preferences -> Advanced -> Bonjour).

Playing Files on a Network Device

The Hegel HD30 can function as a DLNA Digital Media Renderer. This means that it can receive and play media files from a UPnP/DLNA compatible media player.

For details on how to set up your media player, please refer to the user manual supplied with the player.

The Hegel HD30 supports the following formats from a UPnP/DLNA compatible player: PCM (WAV/AIFF), FLAC, Ogg and MP3.

For more tips and tricks about how to use the HD30 with a NAS drive, DLNA players and other software solutions, please go to www.hegel.com/products/dac/HD30.

Using AirPlay

When using AirPlay on the Hegel HD30, you can send the music stream from your AirPlay compatible device, to the amplifier. Start with connecting your Hegel HD30 to your local network using Ethernet cable from network connection (LAN - RJ45) on the back of the HD30, to your router.

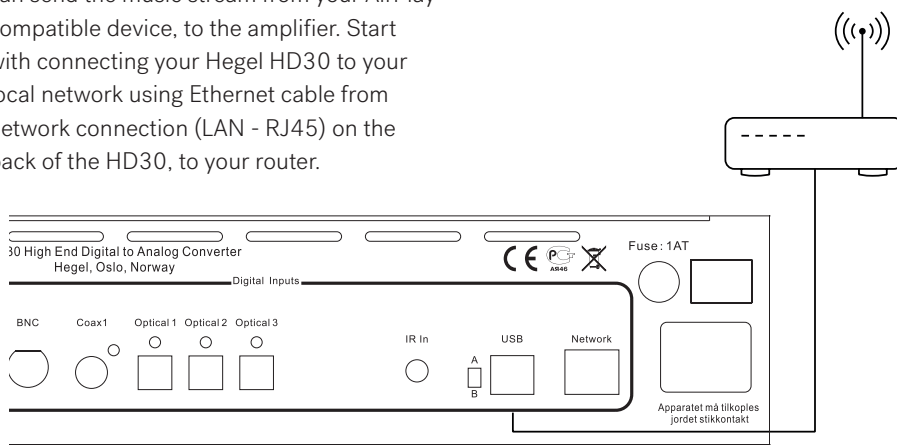

Make sure the Hegel HD30 is connected to your network.

When connected, the unit will set up to DHCP, and will automatically receive an IP-address and then integrate in your home network. All AirPlay compatible devices will now detect the Hegel HD30 in their list of AirPlay speakers, it will be displayed as "HD30", followed by a unique number.

To activate the AirPlay function on your AirPlay compatible device, you must first make sure the device is connected to the same network as the Hegel HD30. For details on this please check the device manual. Then the AirPlay icon will be displayed and you can select the HD30. You are now ready to send the music stream to your amplifier.

Playing from iTunes on your Hegel HD30. Install iTunes 11, or later, on your Mac or Windows computer. Launch iTunes, press the AirPlay Logo, and select the HD30. You can also play to more than one speaker at a time, select the AirPlay logo, then "multiple" and check of the speakers that you want to listen to. You can also adjust the volume on each individual speaker.

[WARNING: After selecting the HD30 as the output, always remember to check the iTunes volume-setting before pressing play. The HD30 will change its volume to the volume set in iTunes, when iTunes starts playing to the HD30.](#)

Remote Control - RC8

The Hegel HD30 can be operated from the included Hegel system remote control RC8. Like other Hegel products, the number of buttons on the RC8 is kept to a minimum.

The Hegel system remote control will also control other Hegel products like CD-players, integrated amplifiers and preamplifiers, avoiding the need for several different remote controls.

The remote control uses two standard 1.5-volt LR03 / AAA batteries. To insert the batteries please use a normal type cross head screwdriver to gently remove the four screws in the bottom of the remote control. Do not use a "Pozidrive" cross head screwdriver, it may damage the head of the screws.

Be sure to insert the batteries with the correct polarity with + sign and - sign as shown inside the battery holder.

Be careful when inserting the screws after fitting the batteries. Please turn the screws gently by hand first to avoid damaging the threads in the remote control body. Do not tighten the screws to hard, as this may damage the screws and the soft metal body of the remote control.

Please do not drop the remote control down on the floor or any hard surface, as this may damage internal parts of the remote control.

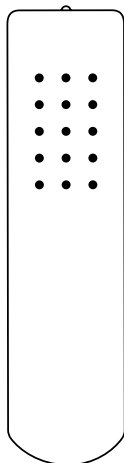

Remote control buttons (starting top left)

1. Skip to previous track on most computers/media players
2. Play/Pause on most computers/media players
3. Skip to next track on most computers/media players
4. Input source selector button for Hegel DACs
5. ECO will put certain Hegel equipment in low power mode
6. Display on/off (hold for off)
7. Skip to previous track on Hegel CD-players
8. Play/Pause for Hegel CD-players
9. Skip to next track on Hegel CD-players
10. Switches up to next input on your Hegel DAC
11. Stop/Eject for Hegel CD-players
12. Volume up for Hegel DAC
13. Switches down to previous input on your Hegel DAC
14. Mute for Hegel DAC
15. Volume down for Hegel DAC

Special Functions

Set Startup Volume

A user defined volume value may be used as the power up volume. The current volume is set as the power up volume by pressing and holding the DAC+ button while pressing Vol- on the RC8 remote control.

Max Volume

A user defined volume value may be used as the max volume.

The current volume is set as the max volume by pressing and holding the DAC+ button while pressing Vol+ on the RC8 remote control. To reset, first put to max volume, then press and hold the DAC+ button, and while pressing, press Vol+ on the RC8 remote control.

Reset to Factory Default Settings

By pressing and holding the DAC+ button while pressing Mute on the RC8, the HD30 will be reset to factory settings. This will clear all user defined settings, including IP settings, and reinitialize the HD30.

Display On/Off

The DISP button on the RC8 remote control may be used to turn the display of the HD30 on or off. Holding the DISP button for more than 1 seconds will turn the display off, while giving the button a shorter push will turn the display on.

IR In

The IR in connection is a remote control input that may be connected to a wired remote control system or an IR repeater. This input may be used to control the H360 in the same way that a Hegel remote control would.

USB Mode Setting:

The USB mode selector switch on the rear panel determines the mode setting of the USB audio interface. Please note that the USB connector must be disconnected before changing this setting.

With the switch set to "A" (default), the USB audio interface is set to plug & play mode, and up to 96kHz and 24bits resolution can be achieved.

With the switch set to "B", the USB audio interface can achieve up to 192kHz and 24bits resolution, and native DSD64 and DSD128. B mode is plug & play when using MAC, with the exception of DSD. With DSD you need additional software, please consult the HD30 section of the Hegel website. If you are using a PC, running a Windows operating system, an additional driver has to be installed on the computer for both PCM and DSD. To download and install the driver, please consult the HD30 section of the Hegel website.

MAC Troubleshooting:

After installation you may need to go to "System Preferences – Sound – Output" and choose your USB Audio DAC as the output device.

General Information

Transport and Shipment

If you are packing the DAC for shipping, please follow these instructions to avoid damaging the unit:

Be careful not to hold the volume- and source-knobs when lifting the DAC.

Put the plastic bag around the DAC. Make sure that the plastic bag does not press tightly on the knobs as this may damage them during transportation.

Make sure the bottom shock absorber is placed at the bottom of the original cardboard box.

Place the DAC into the shock absorber. Place the top shock absorber on top of the DAC.

Make sure the plastic bag is still loose around the volume and source knobs to avoid any damage to the knobs during transport. Close the cardboard box using a suitable tape.

Cleaning

Fingerprints or stains on the front panel or top cover can be removed with a cloth moistened with warm water or a mild detergent suitable for cleaning mirrors and windows.

Technical Specifications

HD30 Reference D/A Converter

Inputs	Up to 24bit 192Hz
DAC IC	32 bit
Digital Inputs	1*AES/EBU 1*BNC 1*coaxial S/PDIF, 3*optical S/PDIF, 1*USB, 1*Network
Line level Output	1*unbalanced fixed(RCA), 1*unbalanced fixed(XLR)
Other Connections	Direct IR in - 3.5 mm jack, max 12V
Frequency response	0Hz-50kHz
Distortion	Less than 0.0005%
Dimensions	10cm x 43cm x 31cm HxWxD 10kg shipment weight. 2,4" x 17" x 12,3" HxWxD 22lbs shipment weight.

Additional Information

Warning

Hegel products should only be opened or serviced by certified technicians. The devices contain electronic components that may cause severe electric shock. Work performed on Hegel products by unqualified personnel may cause serious damage or personal injury.

Opening of the product by non-authorized personnel will void the guarantee.

The products must not be exposed to rain or moisture.

Warranty

All Hegel products come with a 2-year warranty against defective materials and workmanship.

In case you would need any assistance with your Hegel product please find your nearest dealer or distributor by looking at the Hegel web site www.hegel.com. If you experience any problems locating your dealer or distributor please contact info@hegel.com

More Information

For more information, please visit www.hegel.com/products/dac/HD30

Use and Placement

The HEGEL HD30 should be placed on a flat, hard surface for proper cooling. A certain space is required for air circulation above and below the DAC. The DAC must never be placed on a carpet or similar surface that obstructs air circulation through the unit. Nor must it be covered while in use or placed on a narrow shelf or in another confined space.

The DAC will need some break-in time before maximum sound quality can be experienced.

Never lift the HD30 by holding around the volume knob or input selector knob. The HD30 is heavy, and applying pressure may damage the knobs.



AirPlay works with iPhone, iPad and iPod touch with iOS 4.3.3 or later, Mac with OS X Mountain Lion or later, and PC with iTunes 10.2.2 or later.

"Made for iPod," "Made for iPhone," and "Made for iPad" mean that an electronic accessory has been designed to connect specifically to iPod, iPhone, or iPad, respectively, and has been certified by the developer to meet Apple performance standards. Apple is not responsible for the operation of this device or its compliance with safety and regulatory standards. Please note that the use of this accessory with iPod, iPhone, or iPad may affect wireless performance.

AirPlay, iPad, iPhone, iPod and iPod touch are trademarks of Apple Inc., registered in the U.S. and other countries. In Japan, the trademark "iPhone" is used with a license from Aiphone K.K.



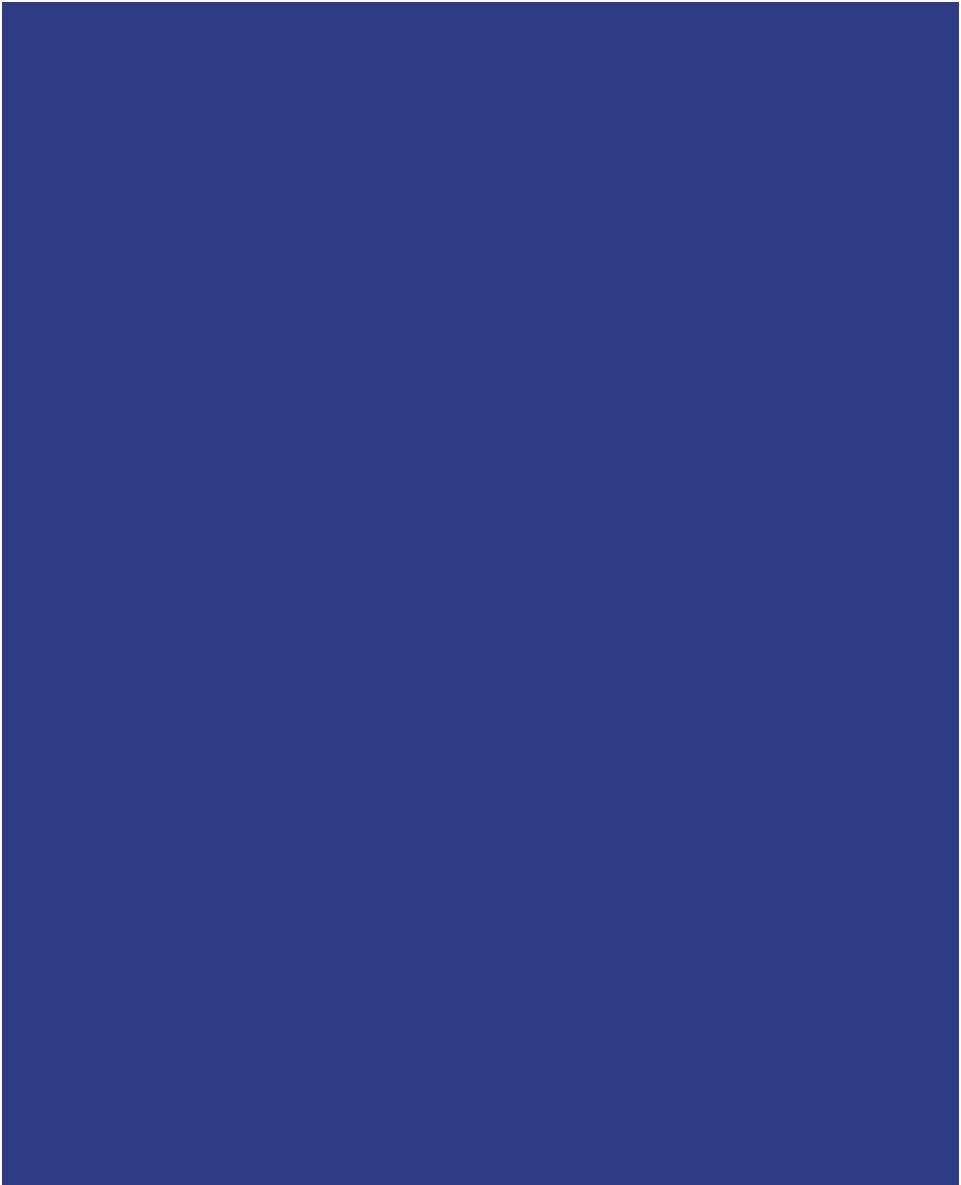

www.hegel.com

