

DIN-THSTAT

DIN Rail Thermostat

The Crestron® DIN-THSTAT is a single-zone thermostat that is designed for use with a variety of heating and cooling systems. DIN Rail mounting allows the DIN-THSTAT to be installed in an equipment cabinet, keeping the living area free from a wall-mounted thermostat.

Remote temperature and humidity sensors (not supplied) gather the environmental conditions of the room and transmit the signal back to the DIN-THSTAT.

Auxiliary ports allow state sensing from HVAC equipment or other custom programming and interface with additional HVAC devices.

The built-in display enables quick and easy commissioning of the HVAC system to get the system up and running.

The thermostat is equipped with two Cresnet® communication ports to enable reliable communication with a Crestron control system and additional Cresnet controlled devices.

Check the Box

Item	Qty
DIN-THSTAT	1
Connector, 4-Pin (P/N 2020555)	2

Mounting to a DIN Rail

NOTE: Observe the following points when installing the DIN-THSTAT.

- Use the DIN-THSTAT in an electrical panel with DIN rail mounting provisions.
- Mount the DIN-THSTAT in a well-ventilated area.
- Do not block the venting holes.

Mount the DIN-THSTAT to the DIN rail (not included):

1. Hang the DIN-THSTAT on the top of the DIN rail.
2. Align the bottom of the DIN-THSAT with the DIN rail and snap it into place.

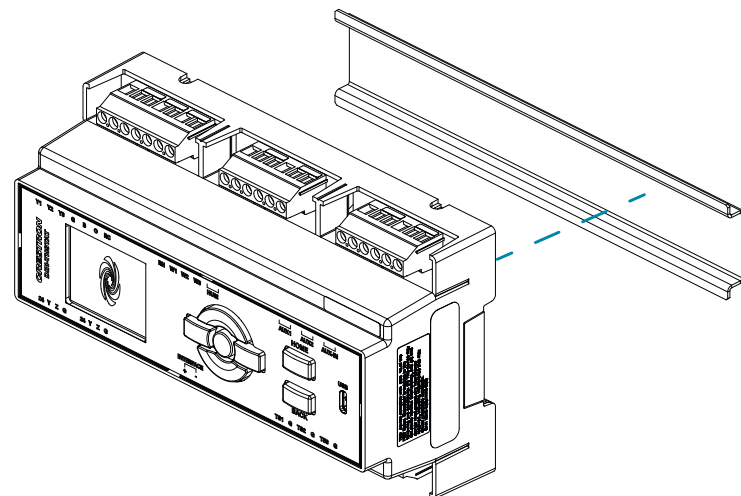

If the DIN-THSTAT needs to be removed from the DIN rail, perform the following:

1. Turn off power to the thermostat and the heating system.
2. Remove all connections from the DIN-THSTAT.
3. Use a small, flat-head screwdriver to pull the DIN rail release tab down.
4. Tilt the bottom of the DIN-THSTAT away from the bottom of the DIN rail and then remove the thermostat.

Wiring HVAC Connections

HVAC Connections:

- Cable Size: AWG: 22 - 14 AWG
- Cable Quantity: 2 per terminal
- Torque: Min 0.5Nm, Max 0.6Nm

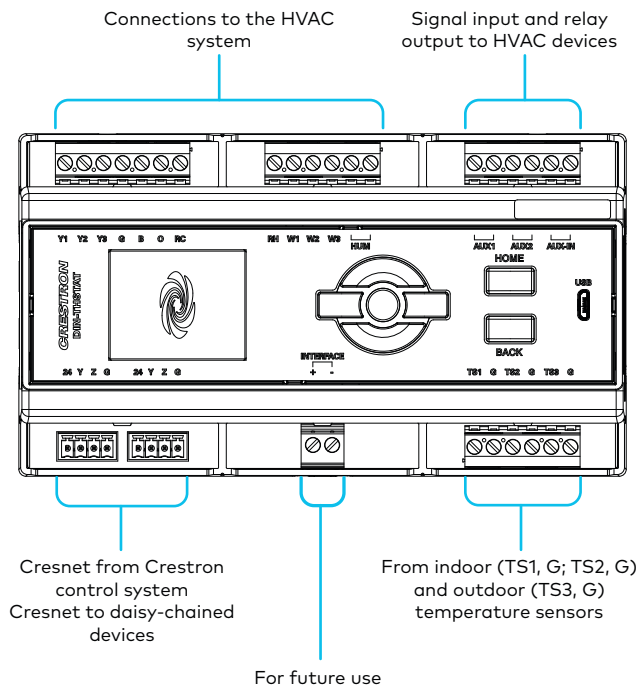

Terminal	Description
Y1, Y2, Y3	Compressor Stage 1, 2, 3 NOTE: Y1, Y2, and Y3 switch to RC
G	Fan Relay
B	Active in non-cool modes
O	Active in cool mode
RC	Reference cool
W1, W2, W3	Heat Stage 1, 2, 3 NOTE: W1, W2, and W3 switch to RH
RH	Reference heat
HUM	Humidistat relay
AUX-IN	Signal from HVAC state sensing or other custom programming
AUX1, AUX2	Output relay to interface with other HVAC devices
TS1, TS2, G	From remote temperature/humidity sensor. Space or slab sensor only.
TS3, G	From remote temperature sensor. Outdoor sensor only.

Temperature Sensor Connections

The DIN-THSTAT uses up to three remote sensors to obtain temperature and humidity levels. The DIN-THSTAT is compatible with Crestron CHV-RTS, CHV-RTHS, CHVI-RTS-1G-N, CHVI-RTS-1G-SM, and CHV-RSS sensors (all not supplied) and 10K thermistors.

Connect space and floor sensors to the TS1 and TS2 terminals. Connect an outdoor temperature sensor to TS3 terminals.

NOTE: Connect one sensor per input.

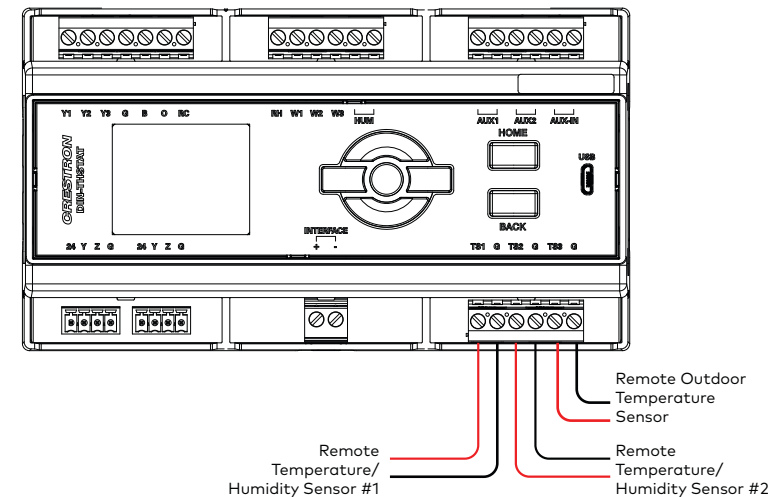

Thermistor Curve

Temperature	k-ohm
-30°F (-34.4°C)	185.42
0°F (-17.8°C)	81.72
40°F (4.4°C)	26.11
80°F (26.7°C)	9.37
90°F (32.2°C)	7.41
110°F (37.8°C)	4.75
120°F (-48.9°C)	3.98

Heat-Cool Application with Separate Systems

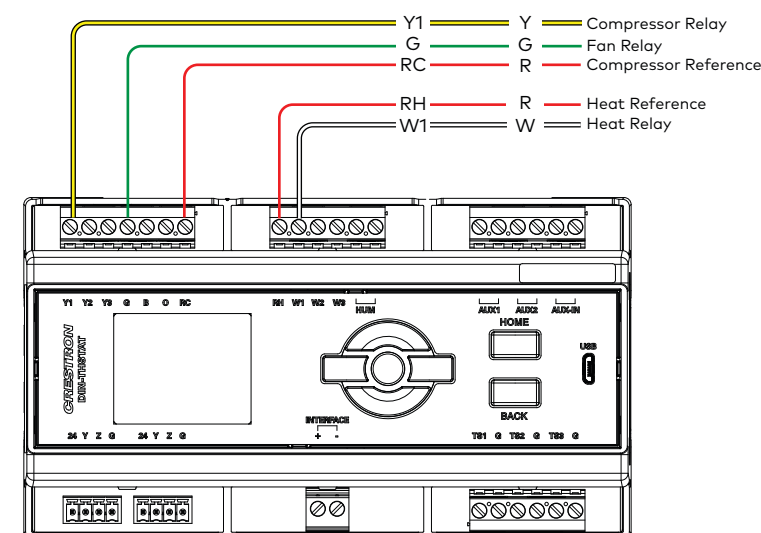

Heat-Cool with Integrated Control Unit

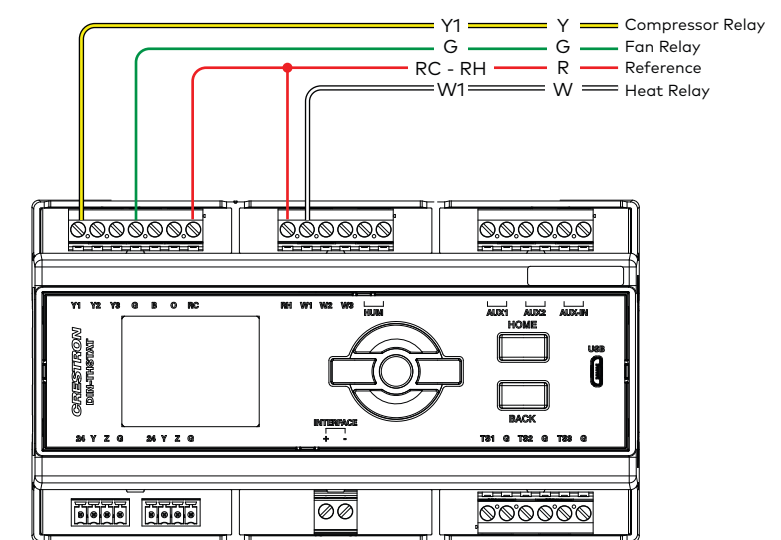

Heat Pump with Integrated Controller (or Dual-Fuel Heat Pump with Integrated Controller)

NOTE: Remove the jumper if the aux system is not controlled through the same interface that has the heat pump connections.

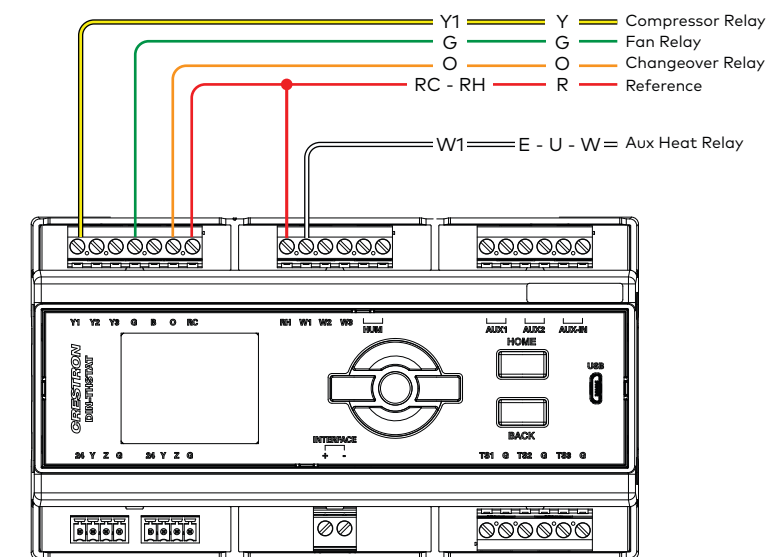

Humidistat Connection

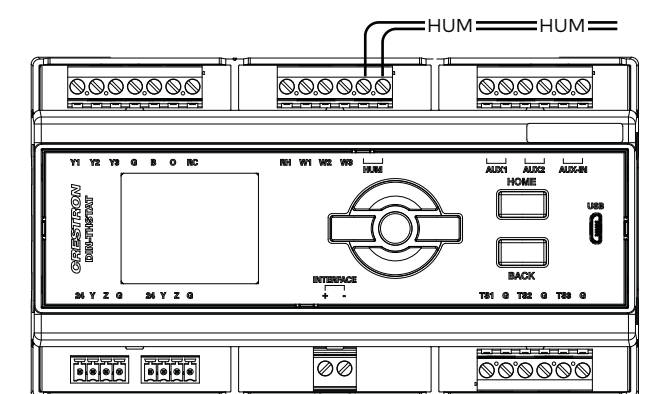

» Front Panel Display

The front-panel display shows the current temperature, setpoint temperature(s), and the operational status.

A screen with three white dots (○○○) on the bottom of the display indicates that there is a sub-page available. Press the select button to enter the sub-page.

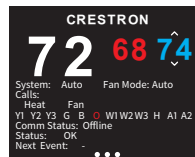

Temperature

The DIN-THSTAT displays the current space (indoor) temperature.

Temperature Setpoint(s)

Displays the temperature setpoint(s).

- White setpoint displays for Single-Setpoint Auto mode.
- Red setpoint displays for Heat mode.
- Blue setpoint displays for Cool mode.
- Red and Blue setpoints display for Dual-Setpoint Auto Mode.

System Modes

Displays the current System mode (**Off, Heat, Cool, Aux, Auto**). Does not indicate that a system call is being made. For details, refer to the "Change the System and Fan Mode" section.

Fan Mode

Displays the current Fan mode (**AUTO, CIRC, ON**). Does not indicate that a fan call is being made. For details, refer to the "Change the System and Fan Mode" section.

Calls

Displays the active calls made by the thermostat. There are four positions on the screen "System Call," "Fan Call," "Humidity Call," and "Floor Warming Call" (from left to right):

System Call: Cool, Aux Heat, Heat, or None displays in position one

Fan Call: Fan On, Fan Circ, or No Fan displays in position two

Humidity Call: De-Humid, Humidify, or blank displays in position three

Floor Warming Call: Floor Warm or blank displays in position four

Terminals (Y1, Y2, Y3, G, B, O, W1, W2, W3, H, A1, A2)

Light to indicate the relay call state. Displays all of the HVAC system terminals. Gray indicates that no call is made, colored text that matches the wire color indicates a call on that terminal.

Comm Status

Displays the current communications status.

Online: The DIN-THSTAT is communicating with the control system.

Offline: The DIN-THSTAT is not communicating with the control system.

Status

Displays errors with readings for the room temperature (INVALID ROOM TEMP), room humidity (INVALID HUMIDITY), floor temperature (INVALID FLOOR TEMP), or blank (no error).

Next Event

Displays the name of the upcoming scheduled event.

» Change the System and Fan Mode

To change the System mode or Fan mode, navigate to the home screen and then press the select button. The **SYSTEM MODE / FAN MODE** screen displays.

System Mode

To change the System mode, press the left, right, up, and down buttons to highlight **OFF, HEAT, COOL, AUX, or AUTO**, and then press the select button to confirm.

Off Mode: All HVAC systems are disabled.

Heat Mode: The thermostat uses the heating system to maintain the setpoint temperature.

Cool Mode: The thermostat uses the cooling system to maintain the setpoint temperature.

Aux Mode: The thermostat uses aux heat only to provide heat. Aux mode may be required during heat pump servicing or when the heat pump cannot maintain the setpoint.

Auto Mode: The thermostat allows the HVAC system to switch between Heat mode and Cool mode automatically to maintain the setpoint temperature. The thermostat can operate in Dual- or Single-Setpoint Auto mode.

Select or disable Auto mode during configuration. For configuration details, refer to the "Configure the DIN-THSTAT" section.

Dual-Setpoint Auto mode:

Dual-Setpoint Auto mode uses separate heat and cool setpoints to regulate the temperature. When the ambient temperature drops below the heat setpoint, the unit calls for heat to maintain the heat setpoint. When the ambient temperature rises above the heat setpoint, the unit does not call for cooling until the temperature exceeds the cool setpoint. When the ambient temperature drops below the cool setpoint, the unit does not call for heating until the temperature is below the heat setpoint.

The **AUTO Deadband** setting determines the temperature separation between the heat and cool setpoints. If a setpoint adjustment violates this separation, the other setpoint is automatically adjusted.

Single-Setpoint Auto mode:

Single-Setpoint Auto mode uses a single setpoint to regulate the temperature at all times regardless of whether the HVAC system is heating or cooling.

The **AUTO Deadband** setting is used to determine when to switch between heating and cooling.

For example, the setpoint is at 70° and the **AUTO Deadband** setting is 2°, if the system is cooling, it does not start heating until the ambient temperature drops below 68° (setpoint - AUTO Deadband). Once the unit has switched to heating, it does not resume cooling until the ambient temperature rises above 72° (setpoint + AUTO Deadband).

NOTE: When using Single-Setpoint Auto mode, the DIN-THSTAT uses a 20-minute change limiter to prevent frequent system toggling. Changing the setpoint resets the 20-minute change limiter.

Fan Mode

To change the Fan mode, press the left, right, up, and down buttons to highlight **AUTO, CIRC, or ON**, and then press the select button to confirm.

CIRC mode: The fan will maintain a ~30% duty cycle. The duty cycle includes the time that the fan runs during heat calls and cool calls.

AUTO mode: The fan will turn on when a cool call or heat call is made. The functionality of the fan during a heat call is determined by the settings made during configuration of the DIN-THSTAT.

ON mode: When the fan is operating in **ON** mode, the fan is always on.

» Operate the DIN-THSTAT

View and change the basic operating functions of the DIN-THSTAT using the on-screen display and the **HOME, BACK**, select, up, down, left, and right buttons. Values that can be changed are the temperature, current schedule, humidity, regulations, messages, and device info. Press the left or right button to navigate to the following screens.

Schedule

The **Schedule screen** displays the schedule that is currently running, the current event, and the upcoming event. The control system program provides the schedule.

The thermostat Schedule mode can be configured to RUN the schedule programmed on the control system or to HOLD the schedule to prevent temperature changes from being made.

To change the Schedule mode:

1. Press the select button. The **SCHEDULE MODE** screen is displayed.
2. Press the left or right button to highlight **RUN** or **HOLD**, and then press the select button to confirm.
3. Press the **BACK** button to return to the previous screen.

When the system exits Hold mode, the system activates the schedule that is desired for that time.

Humidity

The **Humidity screen** displays the current and desired humidity level.

To change the humidity setpoint, press the up or down button to select a value.

To enable or disable Humidifier mode:

1. Press the select button. The **HUMIDIFIER MODE** screen is displayed.
2. Press the left or right button to highlight **ENABLE** or **DISABLE**, and then press the select button to confirm.
3. Press the **BACK** button to return to the previous screen.

Regulation

The **Regulation screen** displays the Space and Outdoor temperature and humidity readings and the Floor temperature reading. If the sensor connected to TS1 and TS2 are both configured as Space sensors, the value displayed is the average of the two sensor readings.

To view the temperature and humidity readings of all connected sensors, press the select button. The **SENSORS** screen is displayed.

Press the **BACK** button to return to the previous screen.

Radiant Floor

The **Radiant Floor** screen displays the current floor temperature and the desired floor temperature setpoint.

NOTE: The Radiant Floor screen is displayed when the radiant floor type is set to Floor Warming or space heating.

To change the floor temperature setpoint, press the up or down button to select a value.

To enable or disable Radiant Floor mode:

1. Press the select button. The **RADIANT FLOOR MODE** screen is displayed.
2. Press the left or right button to highlight **ON** or **OFF**, and then press the select button to confirm.
3. Press the **BACK** button to return to the previous screen.

Message

The **Message** screen displays essential system messages.

Device Info

The **Device Info** screen displays the device information such as the firmware version, serial number, and HW version.

The **Device Info** screen also provides access to the configuration menu on the DIN-THSTAT. For configuration details, refer to the "Configure the DIN-THSTAT" section below.

» Configure the DIN-THSTAT

Configure the DIN-THSTAT to match the connected HVAC system and the usage requirements of the thermostat. Configure the DIN-THSTAT using the Thermostat Configuration Tool in Crestron Toolbox™ software or using the front-panel controls.

CAUTION: Only qualified personnel should make changes to the settings on the following page. Damage to the DIN-THSTAT and HVAC system may occur if incorrect settings are selected.

To configure the DIN-THSTAT:

1. Press the left or right button to navigate to the **Device Info** screen.
2. Press the select button to enter the **Gateway To Config** screen.
3. Press and hold the select button.
4. While holding the select button, press and hold the up and down buttons for 5 seconds. The configuration warning screen displays.
5. Press the select button to enter the configuration menu or press the **HOME** button to exit the configuration menu.

NOTE: The DIN-THSTAT restarts after exiting the configuration menu.

6. Configure the DIN-THSTAT as necessary. To navigate the configuration menu:

- Press the left or right buttons to navigate through the setup screens.
- Press the up or down buttons to highlight items on the page, and then press the select button to change the value.
- When the item is highlighted in red, press the up or down buttons to change the value.
- Press the select button to confirm the selected value and return to the previous page.

To configure the DIN-THSTAT, refer to the DIN-THSTAT Supplemental Guide (Doc. 8318) at www.crestron.com/manuals.

» Additional Information

Scan or click the QR code for detailed product information.



DIN-THSTAT

Compliance and Legal

Federal Communications Commission (FCC) Compliance Statement

This device complies with part 15 of the FCC Rules. Operation is subject to the following conditions: (1) This device may not cause harmful interference and (2) this device must accept any interference received, including interference that may cause undesired operation.

CAUTION: Changes or modifications not expressly approved by the manufacturer responsible for compliance could void the user's authority to operate the equipment.

NOTE: This equipment has been tested and found to comply with the limits for a Class B digital device, pursuant to part 15 of the FCC Rules. These limits are designed to provide reasonable protection against harmful interference in a residential installation. This equipment generates, uses and can radiate radio frequency energy and, if not installed

and used in accordance with the instructions, may cause harmful interference to radio communications. However, there is no guarantee that interference will not occur in a particular installation. If this equipment does cause harmful interference to radio or television reception, which can be determined by turning the equipment off and on, the user is encouraged to try to correct the interference by one or more of the following measures:

- Reorient or relocate the receiving antenna.
- Increase the separation between the equipment and receiver.
- Connect the equipment into an outlet on a circuit different from that to which the receiver is connected.
- Consult the dealer or an experienced radio/TV technician for help.

Industry Canada (IC) Compliance Statement

CAN ICES-3 (B)/NMB-3(B)

The product warranty can be found at www.crestron.com/warranty.

The specific patents that cover Crestron products are listed at www.crestron.com/legal/patents.

Certain Crestron products contain open source software. For specific information, please visit www.crestron.com/opensource.

Crestron, the Crestron logo, and Cresnet are either trademarks or registered trademarks

of Crestron Electronics, Inc. in the United States and/or other countries. Other trademarks, registered trademarks, and trade names may be used in this document to refer to either the entities claiming the marks and names or their products. Crestron disclaims any proprietary interest in the marks and names of others. Crestron is not responsible for errors in typography or photography.

©2019 Crestron Electronics, Inc.

Crestron Electronics, Inc.
15 Volvo Drive, Rockleigh, NJ 07647
Tel: 888.CRESTRON
Fax: 201.767.7576
www.crestron.com

Quick Start - Doc. 8317B
(2051468)
06/24/19
Specifications subject to
change without notice.