



REFERENCE SERIES MODEL 109
THE MAIDSTONE

INSTALLATION MANUAL



KENT ENGINEERING & FOUNDRY
1961

CONTENTS

Important safety instructions	2
General care of your system	2
History	3
<i>The 1970's</i>	4
<i>The 1980's</i>	5
<i>The 1990's</i>	6
Overview	7
Drive units	8
Cabinets	8
Crossover network	8
Design and Development	9
<i>Initial design</i>	10
<i>Design in progress</i>	11
<i>Fine tuning and production</i>	12
Unpacking	13
Positioning the system	13
Assembly	14
<i>Fitting the feet to the LF module</i>	14
<i>Fitting the LMF/Uni-Q module to the LF module</i>	14
<i>Fitting the leather straps</i>	15
<i>Wiring the modules together</i>	15
<i>Wiring the system to your amplifier</i>	16
<i>Bi-wiring</i>	17
<i>Bi-amping</i>	17
Toeing-in the system	18
Adjusting the high frequency output	18
Fitting the grilles	18
Operation with an active crossover network	19
Cables	20
Fault finding	20
Fault finding table	21
Measured performance	22
Crossover network schematics	23
Technical specification	24

IMPORTANT SAFETY INFORMATION

1. Read this manual carefully, especially the safety information, before attempting to assemble and operate the system.
2. Follow the unpacking and assembly instructions on the cartons. Please note that lifting the heavy modules requires two able-bodied persons.
3. Make sure that the leather straps are properly screwed to the modules.
4. These modules are heavy and have spiked feet so take great care when manoeuvring the system.
5. Never connect the system directly to the electricity supply.
6. Ensure that the modules are correctly wired together before connecting to your amplifier. Failure to do this could result in serious damage to the system, your amplifier or the electricity supply.
7. Trailing cables are dangerous. Ensure all cables are secure and tidy.
8. When stripping cables use only tools designed specifically for the purpose ie: correct wire cutters or cable strippers. Do not attempt to strip cables with a knife as this could result in serious injury.

GENERAL CARE OF YOUR SYSTEM

1. Avoid temperature extremes.
2. Avoid damp.
3. Avoid direct sunlight.
4. Clean with a damp, lint free cloth.
5. Do **not** use spirit based cleaners.

If you are at all uncertain about setting up, operating or caring for your system your dealer will be pleased to assist you.



Thank you for purchasing the KEF Reference Series Model 109, The Maidstone, loudspeakers. These loudspeakers have been designed to give high quality sound over many years of use and should provide astonishingly realistic reproduction of music and speech.

Please take a little time to read these instructions prior to use.

HISTORY

KEF was founded in 1961 by an electrical engineer named Raymond Cooke in a Nissen Hut on the premises of a metalworking operation called Kent Engineering & Foundry (hence KEF), on the banks of the River Medway, near Maidstone in Kent. From the beginning KEF was destined to become a company with a flair for the unusual and controversial in terms of loudspeaker engineering, design and use of materials. Within a year, KEF, under Cooke's outstanding vision, was planning loudspeakers with bass units using foil-stiffened, vacuum-formed, expanded polystyrene diaphragms and a Melinex or Mylar tweeter. This idea was manifested in the K1, an immediate success, followed by the bookshelf model, Celeste, a loudspeaker with an even more significant commercial success and one that helped secure the early financial stability of the new company.

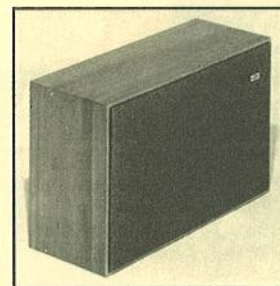
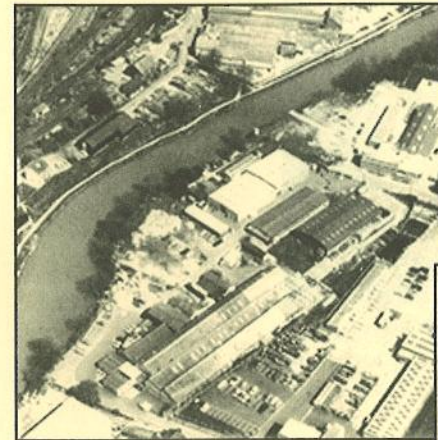

The Celeste bookshelf loudspeaker.

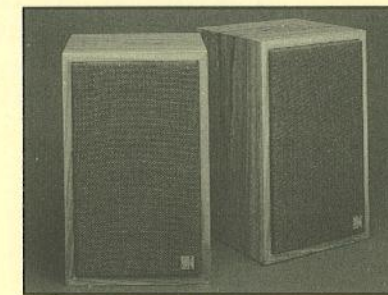

The now famous LS3/5A.

Re-establishing a previous relationship with the BBC in 1966, Cooke was interested in adopting another material, Neoprene (an artificial rubber) to help maintain sound quality in the mid-band by using it as the surround to the loudspeaker diaphragm, while using new materials for the diaphragm itself. Cooke was always looking for new materials and settled on Bextrene as a solution, as its lightweight plastic sheet-like properties were flexible enough for shaping and the material remained stable under varying temperature and moisture conditions and was smooth and consistent over a wide bandwidth. As a result, in 1967, two new drive units, the 5" B110 and 8" B200 appeared which, with their countless applications, found use in some 3 million systems from KEF and many other loudspeaker brands throughout the world. A new, smaller tweeter also arrived, the T27, which led to the most famous BBC/KEF collaboration, the LS3/5A, of which some 100,000 units were sold world-wide. A version of this acclaimed design is still in production today!

During the 1960's KEF flourished. Loudspeakers such as the Concord, Concerto and Cresta and then, in 1969, the Chorale began to shape the company's growing reputation as 'the loudspeaker engineers', a fact justly recognized in 1970 when KEF received the first of two Queen's Awards for Export Achievement.

THE 1970's

By 1973 the company was developing the concept of computer assisted 'Total System' design, at a time when the world's very first 4-bit microprocessor was still in its infancy. KEF engineers, using a given set of parameters, could for the first time actually "see" what the response characteristics of a loudspeaker system would be. KEF was the first loudspeaker company in the world to take the new technology seriously in order to achieve this. Now it was the use of computers and digital test methods which provided the KEF engineers with the relevant crossover and drive unit data at a glance, thus dramatically improving their ability to produce loudspeakers of outstanding accuracy. Amongst other benefits, KEF loudspeakers could now be computer matched as an almost identical pair - to within one-half of a dB.

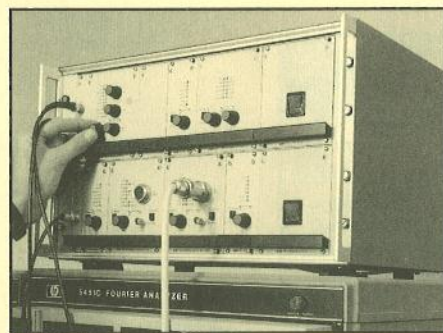

'Total System' design testing equipment

1973 then saw the introduction of the first KEF Reference Series Model, the 104 which swept reviewers, distributors, retailers and customers off their feet. The archetypal 'domestic monitor' 104 provided the standards of a broadcast monitor loudspeaker in a domestic package, probably for the first time.

With the installation of a Hewlett Packard computer at the Maidstone Head Office in 1975, the Corelli, Calinda, and Cantata were all designed under the total system concept and with them came a second Queen's Award for Export in the same year.

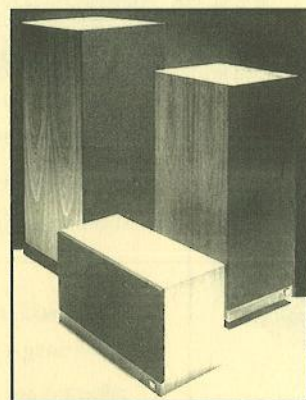

Corelli, Calinda & Cantata models were all designed using the 'Total System' concept.



The Model 105/2

1977 saw the most radical KEF design yet in the Model 105 which apart from setting new standards for flat frequency response introduced a design by which the mid and treble were split from the bass box and placed within a contoured moulded enclosure above the bass enclosure. The added ability to angle the separate unique head unit provided the opportunity for the user to tailor the 105 to his or her own environment. The loudspeaker was of such general importance and consumer interest that a leading quality UK Newspaper, The Daily Telegraph, featured the Model 105 on the front cover of its magazine supplement. More Reference Models were to follow. 1978 saw the launch of the 101 and 103 and, in 1979 a further refined 105/2 Model appeared.

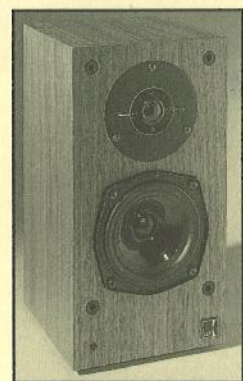

The Model 101

THE 1980's

Ten years of growth world-wide followed, peaking with a massive onslaught on the lucrative and influential US market in 1985 with the setting up of KEF Electronics of America, seen as the appropriate recognition of this important market-place.

1986 saw more activity amongst the now world famous KEF Reference Series; the 104/2, always regarded as one of the world's truly outstanding loudspeakers since its 1984 launch spawned the 107, in reality an evolution of the 105/2 but with KEF's coupled-cavity bass loading, a system which positions the drivers internal to the enclosure, each separately loaded and firing into a third common chamber which delivers very tight and accurate bass to the listening area via a substantial front-mounted port. This combines the taut sonic character of a sealed box with the higher sensitivity of a reflex design and succeeds in providing a huge boost to bass performance. Also came the 102 and the 103/3, both accepted by recording and broadcast engineers as ideal monitors. KEF's reputation as loudspeaker engineers was set in stone. As well as the coupled-cavity bass loading system, KEF Reference loudspeakers boasted such highly sophisticated features as a conjugate load network technique, which makes even a complicated loudspeaker design simplicity itself from the amplifier's perspective and a heavily damped midrange module which preserves low coloration and fine stereo. A force cancelling rod, fitted between the vertically opposed bass units was an added introduction, eliminating the possibility for coloration caused by woofer vibrations exciting the enclosure panels.

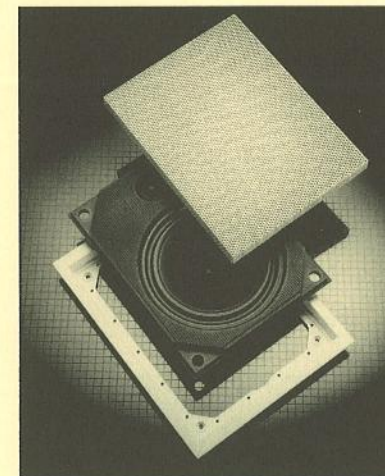

KEF Custom installation speakers (CR200 F) introduced in 1988

Amidst all this excitement, 1988 also brought in the birth of the KEF Custom Installation speakers, a move made in response to new world market demands. The same exacting engineering standards were naturally applied to the range and the CR200F and its sub-bass partner, the CR250SW set new standards from in-wall/ceiling units.

Then, again in 1988, came Uni-Q®. A design process, painstakingly evolved by KEF over several years, by which a single point source at last became a reality. The HF units made use of a rare-earth magnet material, Neodymium/ Iron/Boron which was developed for the NASA Space Programme. 10 times more powerful than a conventional loudspeaker magnet, this material allowed KEF engineers to make a tweeter small enough to fit within the bass unit coil former at the precise acoustic centre of the cone. KEF's Uni-Q technology delivered well-defined stereo imaging over a much wider listening area without the need for the time honoured sacred "hot-spot" in the listening room.

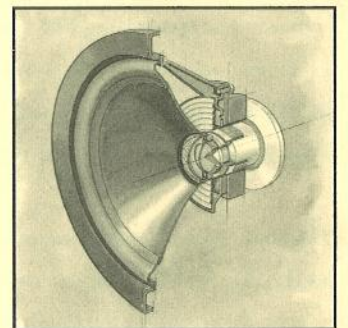

Uni-Q® Technology

The 105/3 was a massive success, bringing together, not just Uni-Q (now in its second generation form), but all of KEF's magnificent technology - coupled-cavity bass loading, conjugate load matching, force cancelling rod, computer matched crossovers and drive units, even hand pair-matched veneer finishes - in fact almost everything by which KEF had made its name as the world's foremost loudspeaker company - in to one product. It was voted Best Imported Speaker by the Japanese Press in 1992.

THE 1990's

Under new ownership in 1992 KEF Audio found itself equipped with new ideas, new personalities and new products. But the same philosophies of solid engineering and innovation to provide the finest quality product available at its particular price-point remained firmly at the bed-rock.

In 1994 and 1995 the company brought out the versatile and appealing Q Series, offering all the benefits of a third generation Uni-Q® driver but in a shielded format for AV use, together with the multi-award winning Model 100 Centre Speaker, the Model 90, the new Model 200C and the Reference Series Models One, Two, Three and Four. KEF also



KEF's Entry level Home Theatre System.

introduced the new entry level Home Theatre System for true audiophile home theatre



The highly successful Coda range, with the award winning Coda 7 in the middle.

sound at a price to fit most pockets. At the end of 1994 the company had quietly launched three loudspeakers that were to become one of the most spectacular success stories in recent KEF history. These were simply called Coda; affordable loudspeakers that took the world's Press by storm, the baby Coda 7 clinching the coveted UK Magazine What Hi-fi?'s "Best Buy" Loudspeaker of the of the Year Award for 1995.

KEF's founding father, Raymond Cooke O.B.E., sadly died during 1996, but with the knowledge that all of his original and noble principles remained intact, and would always do so. Recognition that year for the Reference Series Model Four had reached a peak with world-wide acclaim. Reviews by internationally famed and respected writers were quick to praise the merits of the company's new flagship model with its fourth generation Uni-Q driver and to point out the sheer engineering excellence of the company - an unswerving KEF attribute for over 30 years. Comments such as "the best I've had in my listening room." from the US magazine Stereophile and "KEF's best yet" from UK magazine Hi-fi News were just two of the many plaudits showered on the Model Four.

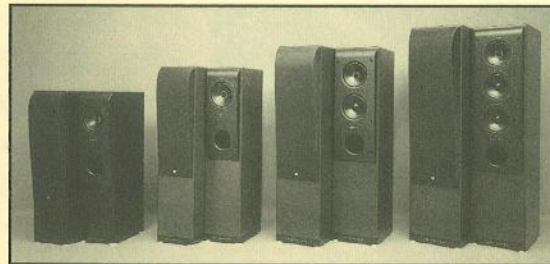

KEF's acclaimed Reference Series

The home theatre series boomed and the company introduced the Model 20B, a baby brother for the Model 30B active sub-woofer. The Coda Series, particularly the Coda 7, continually outsold competing brands throughout the world. 1996 also saw the launch of the new Q Series and the new Monitor Series, superbly crafted loudspeakers to meet the challenges of the next century. Both ranges epitomise KEF's total commitment to engineering qualities beyond all. And now, as the 90's draw to a close, KEF introduce the Reference Series Model 109 - The Maidstone. Over thirty five years of technical excellence, innovation in design and award winning engineering combined in one stunning loudspeaker. The Maidstone is the latest chapter in KEF's illustrious history.

OVERVIEW

The KEF Reference Series Model 109, The Maidstone, is a full bandwidth loudspeaker designed to the highest standard for use in the very best audio systems. It embodies the KEF philosophy of accurate musical reproduction achieved through careful technical design. It is designed to faithfully reproduce the full bandwidth and dynamics of music signals.

Central to the design is the KEF Uni-Q® drive unit, used for the midrange and high frequencies. The co-incident mounting of the two units allows 'point source' operation to be achieved in this critical part of the audio spectrum. In addition, this configuration causes the directivity of the tweeter to be matched to that of the midrange unit, creating a uniform sound over a wide listening area.

To maximize the acoustic performance over the whole audio spectrum it is necessary to divide the frequency range into sections and have dedicated drive units operating in these separate bands. The Maidstone is a four way system with crossover frequencies at 100Hz, 400Hz and 2.8kHz. The sub-bass frequency range below 100Hz is reproduced by a new 15" drive unit in a ported enclosure. The lower mid frequency range, from 100 to 400Hz, uses a specially designed 10" drive unit in a 19 litre sealed enclosure. The frequency range above 400Hz is handled by the latest 5th generation Uni-Q driver in a 6.5 litre sealed enclosure.

Three separate cabinets are used to minimize interactions and to give the optimum structure for each unit. The whole system is tilted back to give correct time alignment of the drivers, ensuring proper integration and coherence. The signal from the amplifier is fed to the drive units via a computer designed electrical crossover network, incorporating high quality polypropylene capacitors and air-cored inductors.

Set-up is simple, but a little more critical than with most conventional loudspeakers.

We therefore ask you to take the time to read this manual carefully as the set-up procedures for assembling and connecting The Maidstone will ensure optimum performance if followed correctly.

If you are at all uncertain your dealer will be pleased to assist you.

DRIVE UNITS

The performance requirement of The Maidstone required new drive units to be specially designed. They incorporate low distortion motor systems and optimally designed diaphragms.

The 15" low frequency driver features a doped paper cone, cast aluminium chassis and a low distortion short-coil/long gap motor system. It also has a double suspension for greater stability.

The 10" lower mid frequency driver features a doped paper cone, cast aluminium chassis and a low distortion short-coil/long gap motor system.

The new 5th generation Uni-Q driver features a 6" doped polypropylene mid frequency cone in a cast aluminium chassis. The tweeter has a 1" doped fabric dome and is ferrofluid cooled. It incorporates a specially shaped, resonance reducing, protection grille and a slit copper foil strip around the magnet system to prevent any coupling distortion.

CABINETS

It is critical for the performance of the system that the enclosures for the drive units are carefully designed. They must properly support the drive units and provide the correct acoustic loading without any form of resonance which may colour the sound.

Laser interferometry techniques have been used in the design of these enclosures to ensure correct performance.

The low frequency section has a 145 litre ported enclosure constructed from 25mm MDF with a 50mm baffle, critically braced for stability and to prevent structural resonance. The lower mid frequency and Uni-Q sections both have sealed enclosures of 19 litres and 6.5 litres respectively. They are constructed from 25mm MDF, internally braced for increased strength and rigidity. The internal damping in the enclosures is critically chosen to provide the optimum acoustic performance.

CROSSOVER NETWORK

The electrical crossover network receives the signal from the amplifier and sends the appropriate output to each drive unit. Sophisticated computer techniques are used in the design of the network to ensure proper integration of the drive units and a total system response that is both technically and subjectively correct. High quality components are used in the network, including low loss polypropylene capacitors and air-cored inductors. The printed circuit board is constructed from high grade fibreglass with gold plated tracks. All internal wiring uses specially chosen oxygen free copper cable.

THE MAIDSTONE

DESIGN
&
DEVELOPMENT

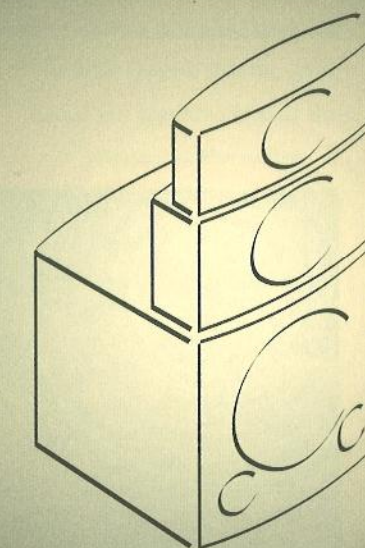

INITIAL DESIGN

In the initial design of a new loudspeaker computer simulation techniques such as Finite Element Analysis are used wherever possible to model the behaviour of the new drive units and cabinets. This allows many different options to be investigated without the need to build and measure real components.

When the engineer is satisfied with the theoretical predictions prototype parts can then be specified and constructed. The engineers work closely with KEF's Industrial designer to ensure that the final design not only has the required acoustic performance but is also pleasing to the eye.

Parts for the prototypes are normally made 'on-site' in the KEF workshop. This gives us the ability to make new parts quickly to a precise specification, ensuring complete control in the development process.

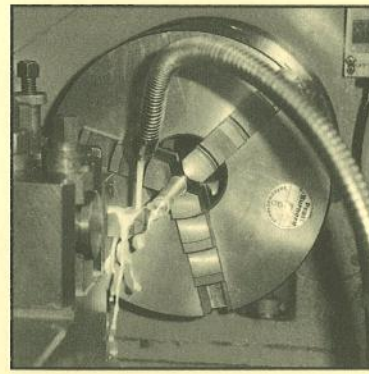

Turning the prototype parts

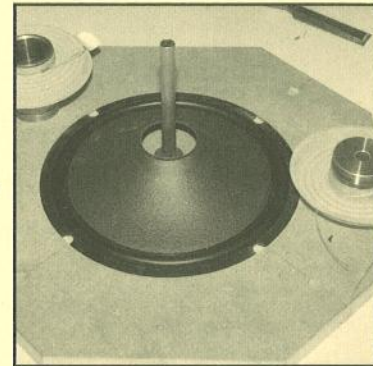

Cone assembly

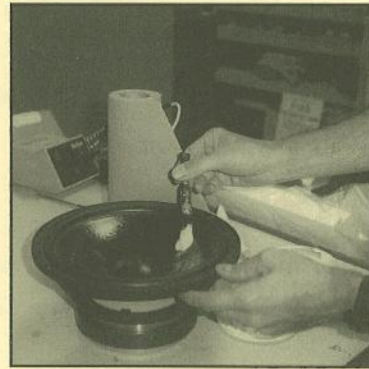

Doping the cone of the first prototype 10" unit



Assembling the first prototype drive units

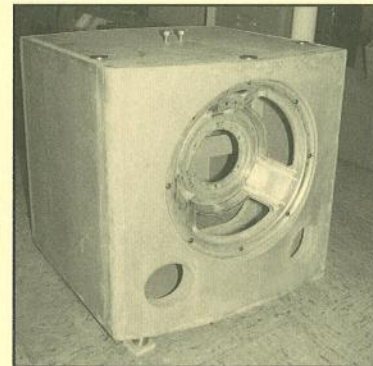

Prototype woofer enclosure, preliminary mechanical and acoustic testing

DESIGN IN PROGRESS

When the engineers are satisfied with the prototype drive units and cabinets, work can then start on the crossover network. The system moves into KEF's advanced acoustical measurement facility where it undergoes an elaborate testing routine. The acoustic responses of each drive unit are measured over a wide range of positions and this data is used in the crossover network simulation program. This program will simulate the frequency response of the loudspeaker for a particular choice of network. Computer optimisation routines are used to determine the best filter shape for each unit in the system such that when all units are working together the desired system frequency response is obtained.

The printed circuit boards can then be designed and real networks built up for measurements and the first listening sessions. It is a requirement for KEF systems that the grille should not significantly alter the response of the system. A considerable amount of time is therefore spent testing both the mechanical and acoustical characteristics of different grille designs and fixing methods.

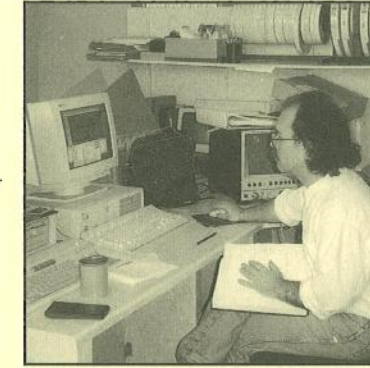

Computer design of crossover



Acoustic measurements of prototype units

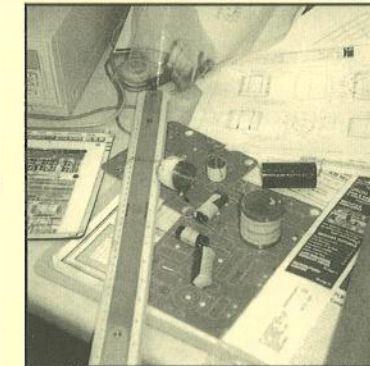

Designing the crossover PCB



Prototype grille

FINE TUNING AND PRODUCTION

Several listening sessions are devoted to fine tuning the sound of the speaker using appropriate high-end electronics and cables. The system is set up in a variety of listening rooms to ensure a good correlation between the measured response and room integration. A skilled listening panel makes sure the loudspeaker meets all of the criteria set out at the beginning of the project.

Prior to full production all components in the system are fully tested for strength and longevity. The system is power tested and an environmental test chamber is used to ensure that all parts in the system will perform correctly under extreme conditions.

A special dedicated build area has been set up for the production and testing of The Maidstone, allowing for the time and care required in assembling a product of this type.

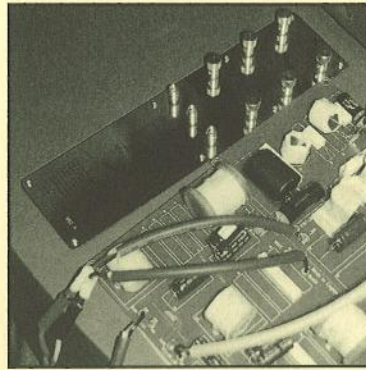

Subjective tuning with crossovers out of cabinet



Preparing for listening session

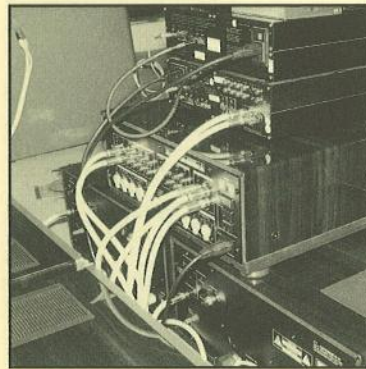

High end electronics used in listening session

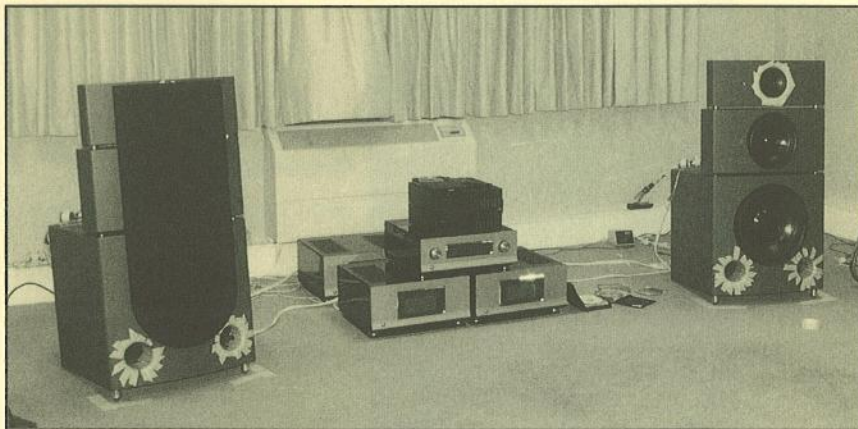

Typical set up used during listening session

UNPACKING

One pair of Maidstone loudspeakers are supplied in five separate cartons.

Two cartons each containing one LF module

one carton containing - LF module A

two feet packs

each containing two front feet, two rear feet, four cups, four gold plated M8 nuts and four M8 washers.

one tool pack

containing one spanner and one L-shaped allen key.

one carton containing - LF module B

one leather straps pack

containing four leather straps, eight gold plated M5 screws and eight gold plated M5 washers .

one cables pack

containing two LMF cables, two MF cables and two HF cables.

Two cartons each containing one LMF/Uni-Q module

One carton containing two grilles

We suggest you retain the packaging in case a need arises for you to transport the speakers at a later date. Please also ensure that the serial numbers of the speakers supplied to you match each other (e.g. 05000A and 05000B) as each pair of speakers are matched to each other, both acoustically and cosmetically.

Unpack the LF modules and the LMF/Uni-Q modules as per the instructions printed on the cartons.

Unpack the grilles and put them to one side.

Their use is optional. If you intend to use them we suggest you put them on the speaker only after listening and positioning tests have been completed.

POSITIONING THE SYSTEM

The Maidstone is designed to be used in 'free space', away from the walls of the room. This ensures that the low frequency response is even and well defined and that the stereo image is

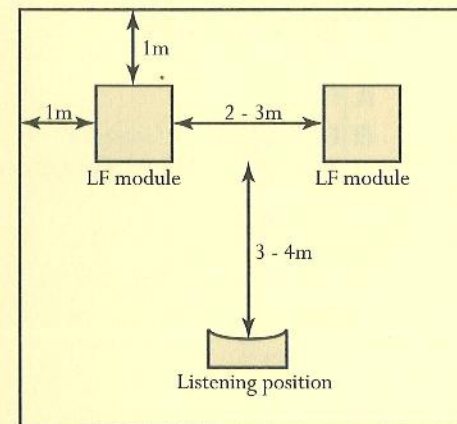

stable and has the correct dimensions in width, height and depth. It is recommended that the systems are positioned at least 1 metre from any boundaries. The systems should ideally be positioned symmetrically in the room, the two systems being the same distance from their respective side walls. Asymmetry in the positioning can cause a distortion of the stereo image. Spacing the speakers approximately 2 to 3 metres apart will allow the stereo image to develop fully. The listening position should be at least equal to and preferably greater than the distance between the speakers.

Positioning the speaker in a corner or near to a side wall is not recommended as the significant bass boost caused by this position will affect the sound and cause the stereo image to deteriorate. Be aware that soft furnishings near to a speaker will deaden the sound - similarly, nearby reflective surfaces may brighten up the sound.

The sound of the system can be sensitive to quite small changes in the positioning. If required, move the speakers until you are satisfied that the sound is right and that the stereo image is well defined.

ASSEMBLY

i) Fitting the feet to the LF module.

WARNING! Do not tip the LF module to the front or to the back as this may damage the cabinet.

Tilt the cabinet on to its left edge.

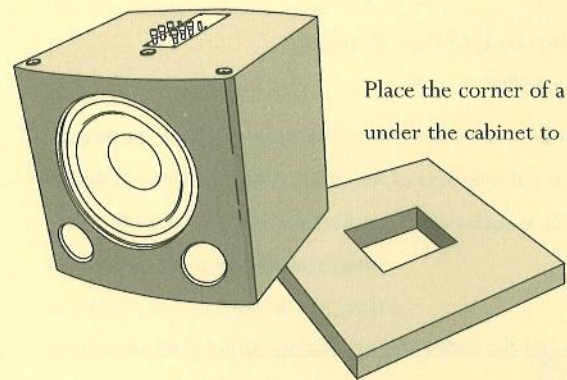
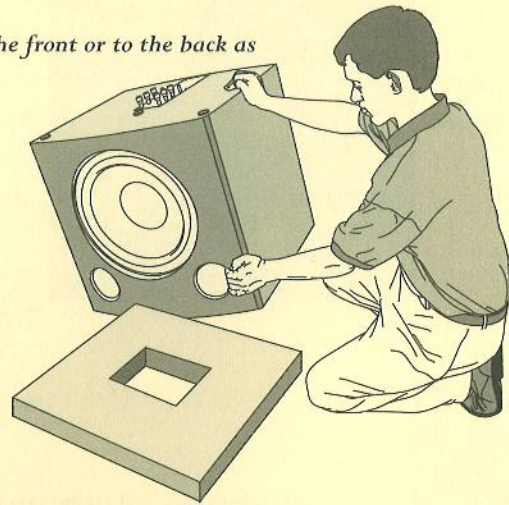

Place the corner of a packing piece under the cabinet to support its weight.

Fit the large feet to the front of the cabinet and small to the rear - and position cups if the speakers are to be stood on a hard floor.

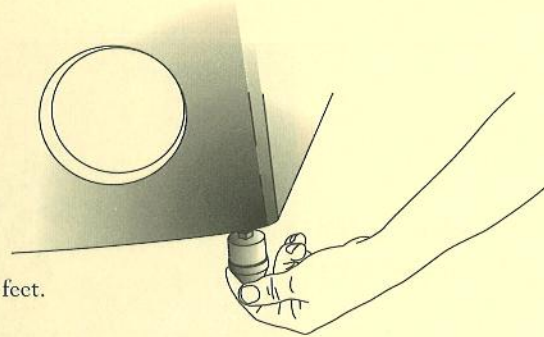

Remove packing piece and repeat procedure for opposite feet.

ii) Fitting the LMF/Uni-Q module to the LF module.

2 people should lift the LMF/Uni-Q module onto the LF module taking care to align the front surfaces of the two units. When the LMF/Uni-Q module is correctly positioned the spikes on the base of the LMF/Uni-Q module should locate positively in the cups on the top of the LF module.

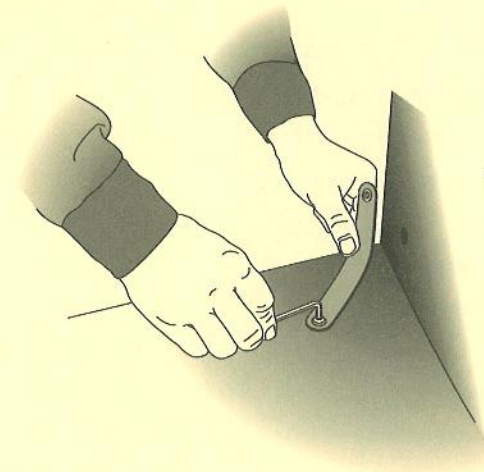

iii) Fitting the leather straps.

Leather straps are provided to tie together the LF module and the LMF/Uni-Q module for added stability. Fix the straps onto the units using the screws and allen key provided.

iv) Wiring the modules together.

Speaker cables are provided for you to wire together the modules.

The following diagrams show how the cables must be fitted.

WARNING! Incorrect wiring could damage your speakers.

Please follow these instructions carefully.

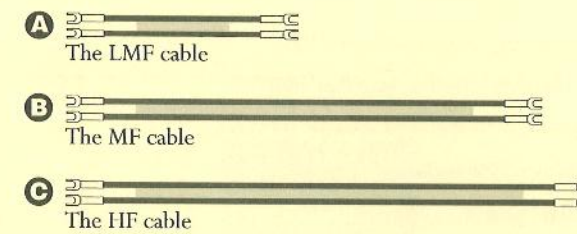

There are three speaker cables for each system. Each cable is clearly marked with a RED termination for the positive (+) connection and a BLACK termination for the negative (-) connection.

Cable Direction.

The 3 cables should be fixed so that the arrows on the positive conductor point from terminal plate to module inputs.

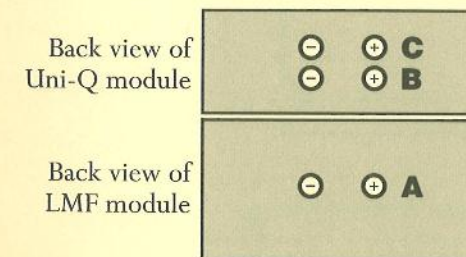

Using cable **A** (the LMF cable) connect the **A** (LMF) terminals on the terminal plate on the top of the LF module to the **A** (LMF) terminals on the back of the LMF module.

Using cable **B** (the MF cable) connect the **B** (MF) terminals on the terminal plate on the top of the LF module to the **B** (MF) terminals on the back of the Uni-Q module.

Using cable **C** (the HF cable) connect the **C** (HF) terminals on the terminal plate on the top of the LF module to the **C** (HF) terminals on the back of the Uni-Q module.

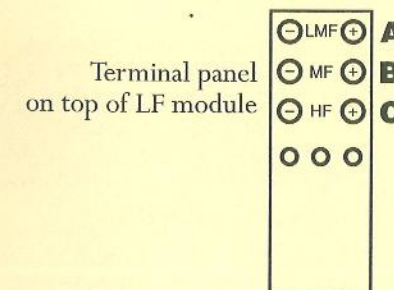

To connect cables, loosen terminal cap and slide cable termination between cap and terminal, retighten terminal cap until cables are held firmly in place.

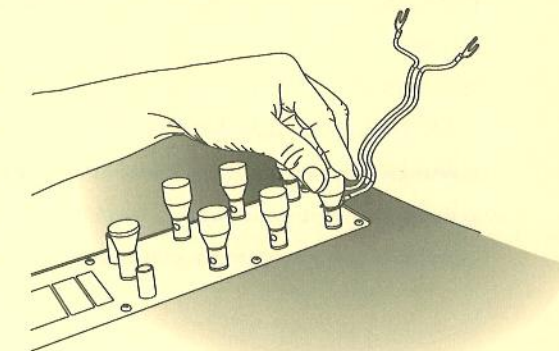

v) Wiring the system to your amplifier.

WARNING! Before connecting your amplifier to the main inputs ensure that the LMF, MF and HF connections are in place between the LF module and the LMF/Uni-Q module. Failure to do this may result in damage to your amplifier.

All connections should be made with the amplifier switched off and disconnected from the mains supply. Ensure the integrity of connections prior to switching the amplifier on.

The Maidstone loudspeakers are fitted with purpose designed gold-plated bi-wire/bi-amp terminals which will accept either bare wire or spade connectors.

Most good quality speaker cables have some indication, such as colour coding or 'ribbing' on the insulating material, as to which conductor is '+' or positive.

Connection to the speakers can then be made as follows:

The right channel amplifier output terminal marked +, positive or coloured RED connects to the right speaker terminal marked +. The right channel amplifier output terminal marked -, negative or coloured BLACK connects to the right speaker terminal marked -. Similarly, these instructions should be followed for making connections between the left channel amplifier output and the left speaker.

Bare wire connections are the most popular and involve stripping 12.5mm (1/2") of insulation to expose the speaker wire core. Making sure that your fingers are clean, twist together the ends of each multi-stranded core prior to the next stage to ensure a better signal contact. Remove the shorting bars between the HF/MF input terminals and the LF input terminals on the back of the LF module. Loosen the screws in the

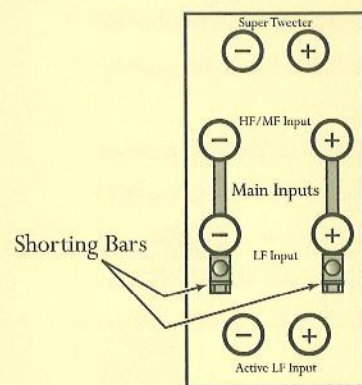

ends of the shorting bars with the spanner provided and push the exposed core of the +(positive) cable into the connection hole of one of the bars, and the exposed core of the -(negative) cable into the connection hole of the other bar. Tighten the screws on the shorting bars to hold the cables securely in place and replace the bars back into the HF/MF and LF input terminals making sure that the +(positive) bar goes into the + terminals and the -(negative) bar goes into the - terminals.

(This method of wiring your amplifier to your speakers is shown as NORMAL in the diagrams opposite.)

WARNING! Make sure that no stray strands come into contact with the opposite terminal or the back plate of the terminals as this could cause a short circuit between the terminals and may damage your amplifier.

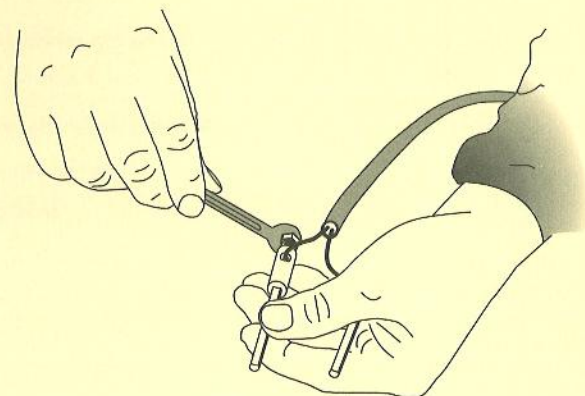

Bi-wiring/Bi-amping terminals.

The LF terminals and HF/MF terminals are linked by a shorting bar which is used in the normal wiring configuration. Removal of this shorting bar will allow the HF/MF and LF inputs to be connected separately, either by parallel connection from one amplifier (known as bi-wiring) or from separate power amplifiers driven from the same pre-amplifier (known as bi-amping).

The LF input connects to the crossover board for the LF and LMF drive units. The HF/MF input connects to the crossover board for the Uni-Q driver.

Bi-wiring:

In this configuration the shorting bar is removed, thereby separating the LF/LMF and HF/MF sections of the crossover network. A pair of cables is then used to connect the amplifier to the loudspeaker. The two cables are connected together at the amplifier output. At the loudspeaker the two cables separately connect to the LF input and HF/MF input terminals on the loudspeaker. This configuration helps to reduce interactions between the two sections of the crossover network and generally results in a sound with better clarity and definition.

Bi-amping:

In this configuration two separate amplifier channels are used to drive the LF and HF/MF inputs of the loudspeaker. A single cable is used to join the amplifier output to the relevant input on the loudspeaker. The main advantage of this mode is that the amplifier being used to drive the HF/MF section is freed from of the need to drive the demanding LF section. A separate amplifier channel is dedicated to the LF section which is normally harder to drive because of the large current it has to supply. The sound quality of a bi-amplified system generally exhibits better control, clarity and separation, particularly in the mid to high frequencies.

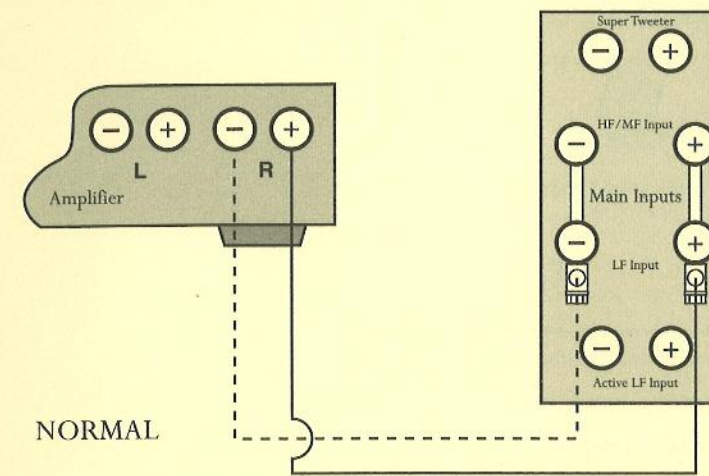

WARNING! Before bi-wiring or bi-amping your system remove the shorting rods from the HF/MF and LF terminals.

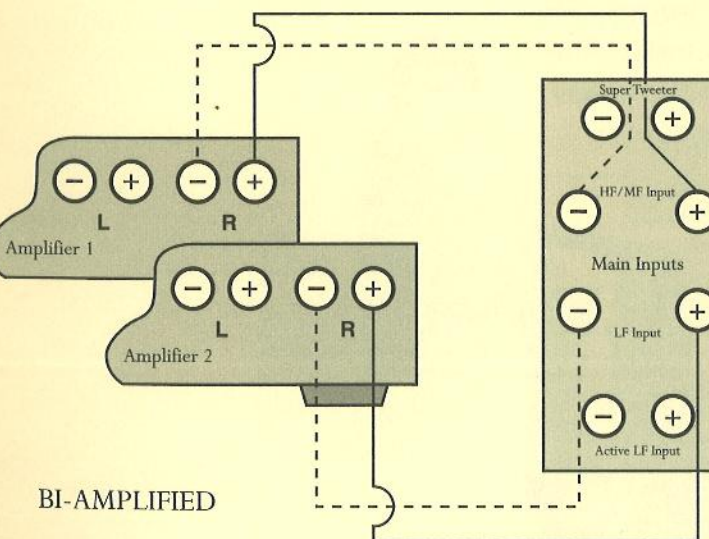
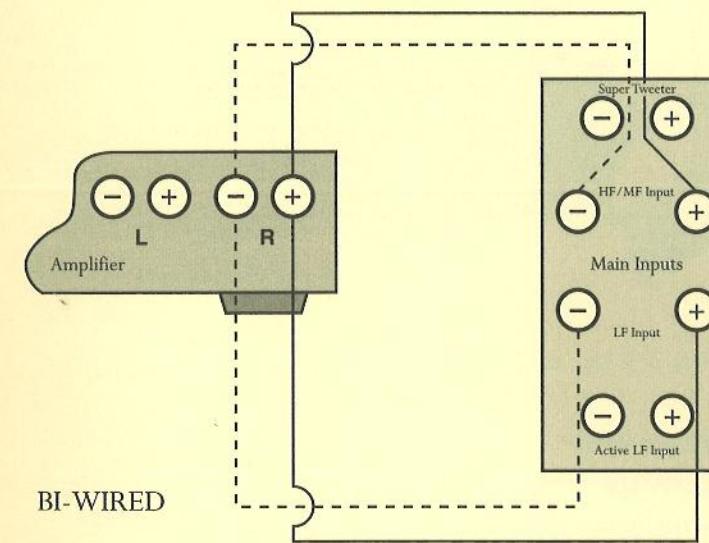

Only one channel shown

TOEING-IN THE SPEAKERS

The sound of the system will be affected by the degree to which the speakers are 'toed-in' towards the listener. Both the stereo image and the tonal balance will change slightly as the angle of toe-in is altered. It is a good idea to experiment to find the best set up for a given room. We would recommend little or no toe-in to start with, increasing the angle until the preferred balance is achieved.

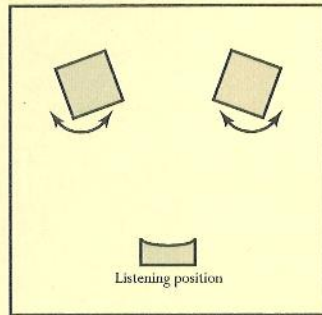

ADJUSTING THE HIGH FREQUENCY OUTPUT

The Maidstone has a facility to adjust the balance of the high frequency output. By changing the the HF Level setting on the terminal panel on top of the LF module the high frequency response can be tilted up or down by approximately 1dB. The high frequency level is set by screwing the terminal cap into the appropriate socket. The unit is delivered with the terminal set in the 0dB position. Experimentation will determine the preferred balance for a particular system set-up and listening room. If the listening room is quite 'live' then the -1dB setting may sound best, if the room is rather 'dead' then the +1dB should be tried.

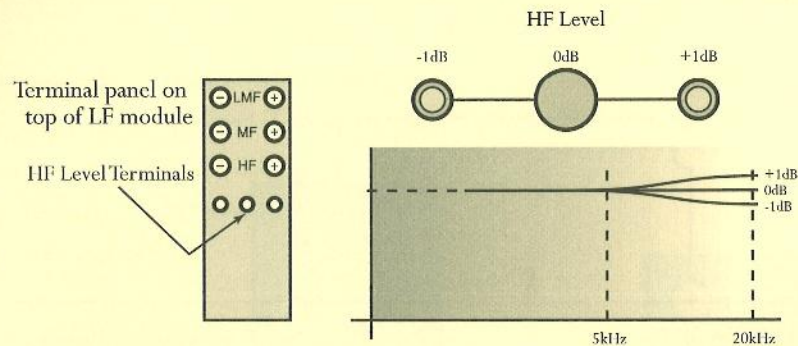

FITTING THE GRILLES

The Maidstone loudspeakers are supplied with carefully designed grilles which serve two primary functions. On a most basic level, the grille cloth protects the drive units from dust and damage, while on an aesthetic level, they soften the look of the loudspeakers. Some listeners, however, believe that the presence of a grille cloth between the drive units and the listener will act as a 'filter' on the sound, possibly affecting the upper frequencies and 'openness' of the sound.

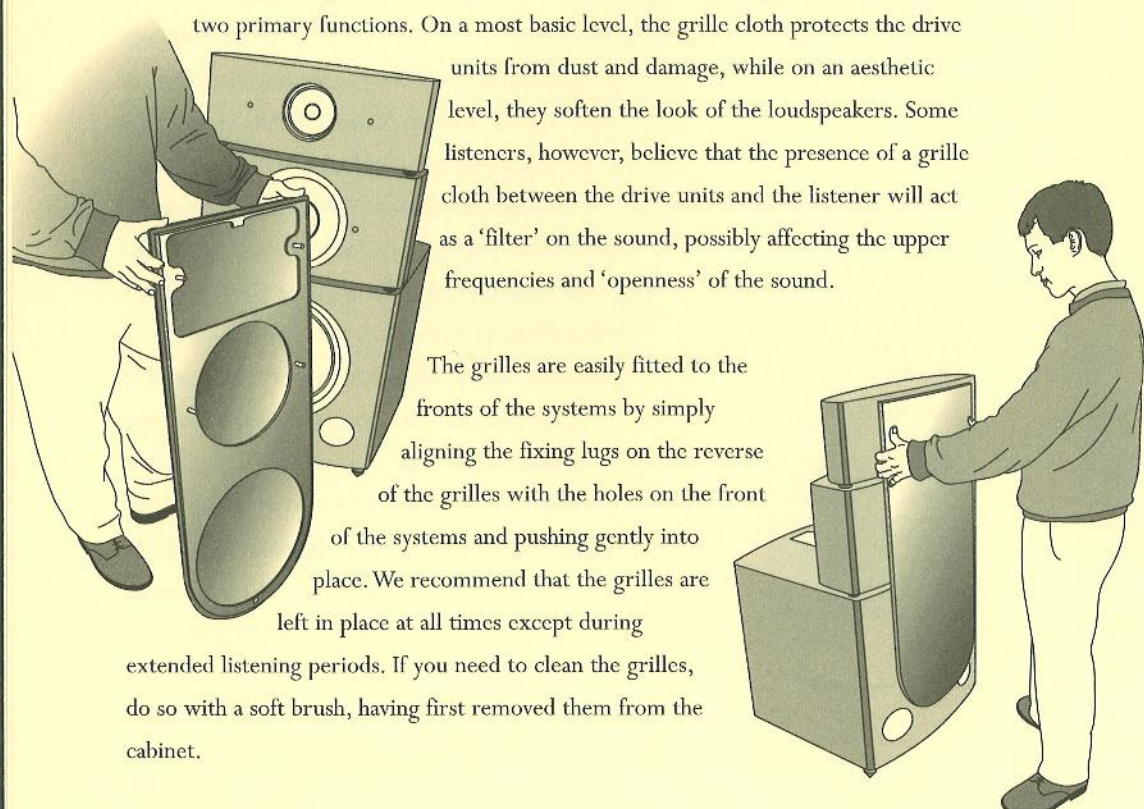

The grilles are easily fitted to the fronts of the systems by simply aligning the fixing lugs on the reverse of the grilles with the holes on the front of the systems and pushing gently into place. We recommend that the grilles are left in place at all times except during extended listening periods. If you need to clean the grilles, do so with a soft brush, having first removed them from the cabinet.

OPERATION WITH AN ACTIVE CROSSOVER NETWORK

The Maidstone system is designed so that, if required, an active crossover can be used in place of the supplied passive network.

WARNING! *It is essential in this mode of operation that the passive network is disconnected from the drive units. Please read the following instructions carefully before reconfiguring the system for active operation.*

i) Disconnecting the LF unit from the passive network.

The lowest pair of terminals on the terminal plate located on the back of the LF module are labelled 'Active LF input', these terminals are specially designed with a dual state facility that must be properly set for the mode of operation. Inside the body of the 'Active LF input' terminals is a small threaded cap which can be inserted flat face pointing inwards, mode A, or flat face pointing outwards, mode B. Mode A is for passive operation, mode B is for active operation. When the loudspeaker leaves the KEF factory the terminals are set to mode A, passive mode.

To set the terminals for active operation please follow this procedure for both terminals:

- 1 - remove the terminal cap
- 2 - unscrew and remove the threaded cap
- 3 - turn the cap around so that the flat face is pointing outwards
- 4 - screw the threaded cap back into the terminal body
- 5 - replace the terminal cap

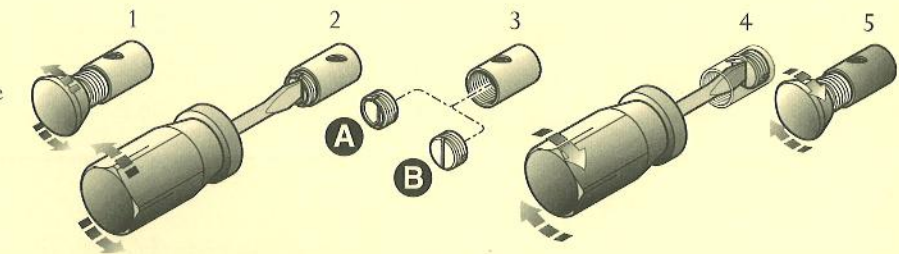

The output from the active LF amplifier can then be connected to this pair of terminals.

ii) Disconnecting the LMF, MF and HF units from the passive network.

For the LMF, MF and HF sections this simply means removing the 3 interconnecting cables which run from the terminal plate on the top of the LF module to the drive unit inputs on the rear of the LMF and Uni-Q module.

The outputs from the active LMF, MF and HF power amplifiers should then be connected to the drive unit inputs on the rear of the LMF and Uni-Q module.

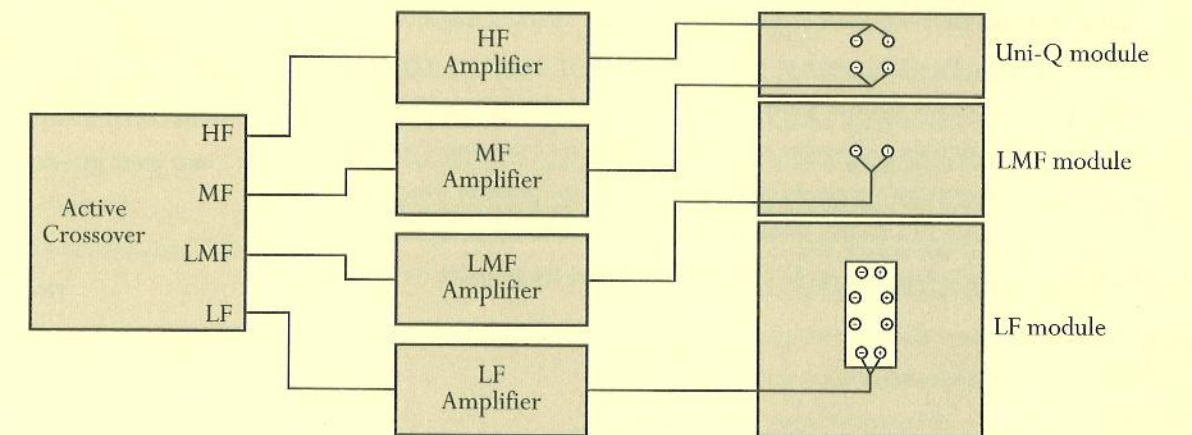

WARNING! *The terminals must be set in mode B as shown above.*

CABLES

To maximize the performance of 'The Maidstone' system you should ensure that the cables used from amplifier to loudspeaker are of good quality. It is important that the total resistance of the cable should not exceed 0.2 Ohms. Always try to keep the cable run to the loudspeakers as short as possible to minimize power and high frequency losses. The following table shows the maximum length that can be used in various gauges without significant effect on the frequency response of the loudspeaker. Ensure that all connections are good, clean and secure. It is good practice to occasionally remake all connections. In the case of bare wire terminations cut back the insulation to expose fresh conductor.

Wire type/area mm ²	Resistance per metre (Ω)	Length for 0.2 Ohms (m)
0.75	0.046	4.3
1.0	0.034	5.8
1.25	0.027	7.2
1.5	0.023	8.7
2.5	0.014	14.5
4.0	0.008	23.3
6.0	0.006	35.1
10.0	0.003	58.8
AWG		
18	0.042	4.7
16	0.026	7.6
14	0.016	12.1
12	0.010	19.2
10	0.006	30.8
8	0.004	48.8

FAULT FINDING

Loudspeakers are inherently reliable and rarely give trouble. It is important to remember that faults arising in any part of the reproducing system will be heard via the loudspeakers and therefore, when faults occur, careful and analytical diagnosis will be required to locate the actual source of trouble. Loudspeakers cannot generate hiss or hum. Spurious noises of this type generally originate in the electronics sections of the equipment or even in the programme source itself. Faults in a loudspeaker will be audible on all programme sources. In the unlikely event that a problem arises with your system the following fault finding guide will give guidance in determining the source of the trouble. If you believe there to be a fault in your system always check the connections first.

PROBLEM	POSSIBLE CAUSES	ACTION
Neither loudspeaker or channel appears to be working	(i) an amplifier or source component fault (ii) a fault in both loudspeakers (iii) a fault in both speaker cables	This can only be checked by replacing components in the system for known working parts. For example: replace the loudspeakers for known working loudspeakers. If there is still no sound from either loudspeaker then the amplifier, source component or cables are faulty.
Only one loudspeaker or channel appears to be working (for example: only the left channel appears to be working)	(i) right channel of the amplifier is faulty (ii) right loudspeaker is faulty (iii) the right cable(s) is faulty	Switch the speaker cables*. If there is still no sound from the right loudspeaker then the loudspeaker is faulty. If the right loudspeaker is now working but the left loudspeaker is not then the fault is in the right amplifier channel or the right speaker cable.
One or more of the drive units do not appear to be working	(i) the relevant section in the loudspeaker is faulty (ii) the interconnecting cable for that section is faulty (iii) the Main Input shorting rods are not connecting properly	(i) Ensure that the shorting rods are properly connected. (ii) replace the interconnecting cable for the faulty section. If the problem still exists then the loudspeaker section is faulty, if the problem disappears then the interconnecting cable was faulty.
A distorted sound is coming from both loudspeakers	(i) an amplifier or source component fault (ii) a fault in both loudspeakers (iii) a fault in both speaker cables	This can only be checked by replacing components in the system for known working parts. For example: replace the loudspeakers for known working loudspeakers. If there is still a distorted sound from both loudspeaker then the amplifier, source component or cables are faulty.
A distorted or intermittent sound appears to be coming from one loudspeaker or channel (for example: distorted sound from the right channel)	(i) right channel of the amplifier is faulty (ii) right loudspeaker is faulty (iii) the right cable(s) is faulty	Switch the speaker cables*. If there is still a distorted sound from the right loudspeaker then the loudspeaker is faulty. If the right loudspeaker is now working properly but the distorted sound is now coming from the left loudspeaker then the fault is in the right amplifier channel or the right speaker cable.

*Switch Cables: connect the left speaker cable to the right loudspeaker and the right speaker cable to the left loudspeaker.

MEASURED PERFORMANCE

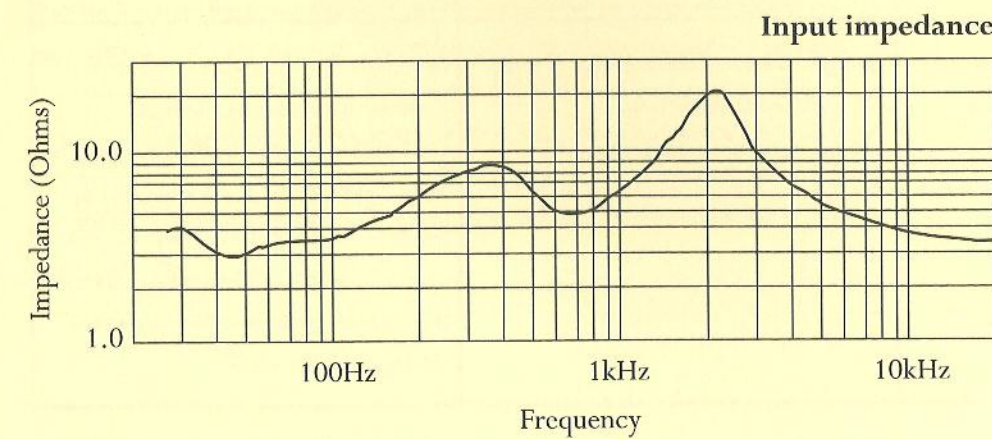
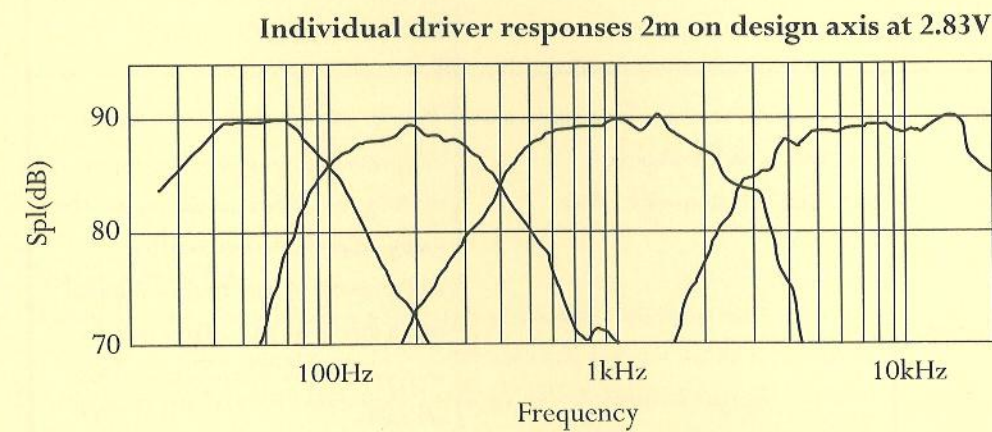
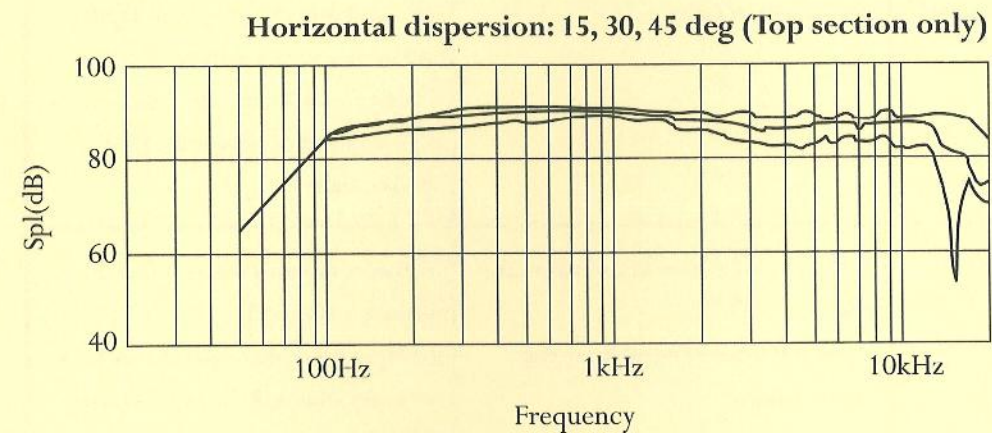
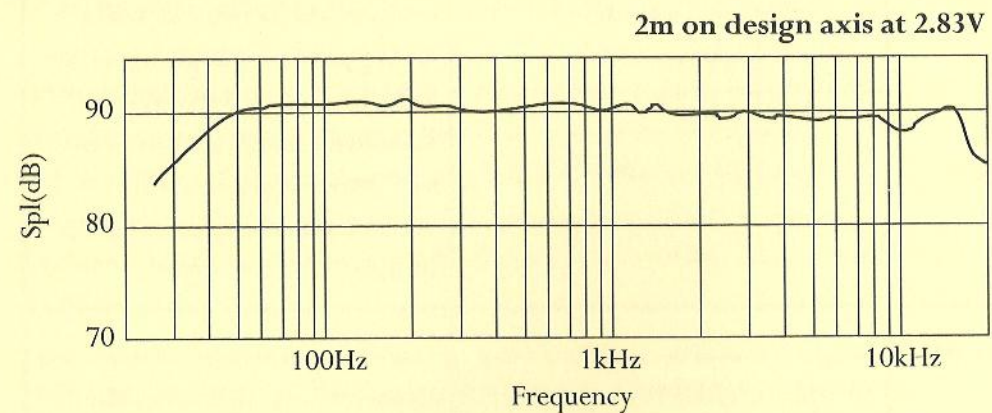

CROSSOVER NETWORK SCHEMATICS

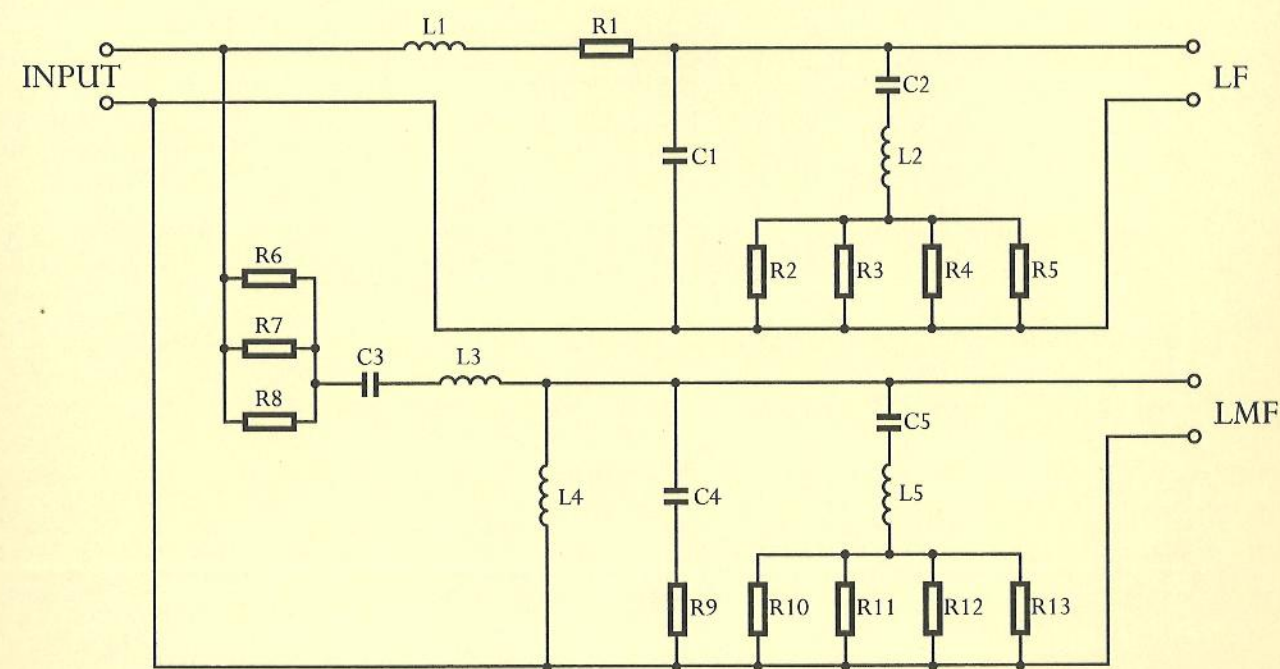
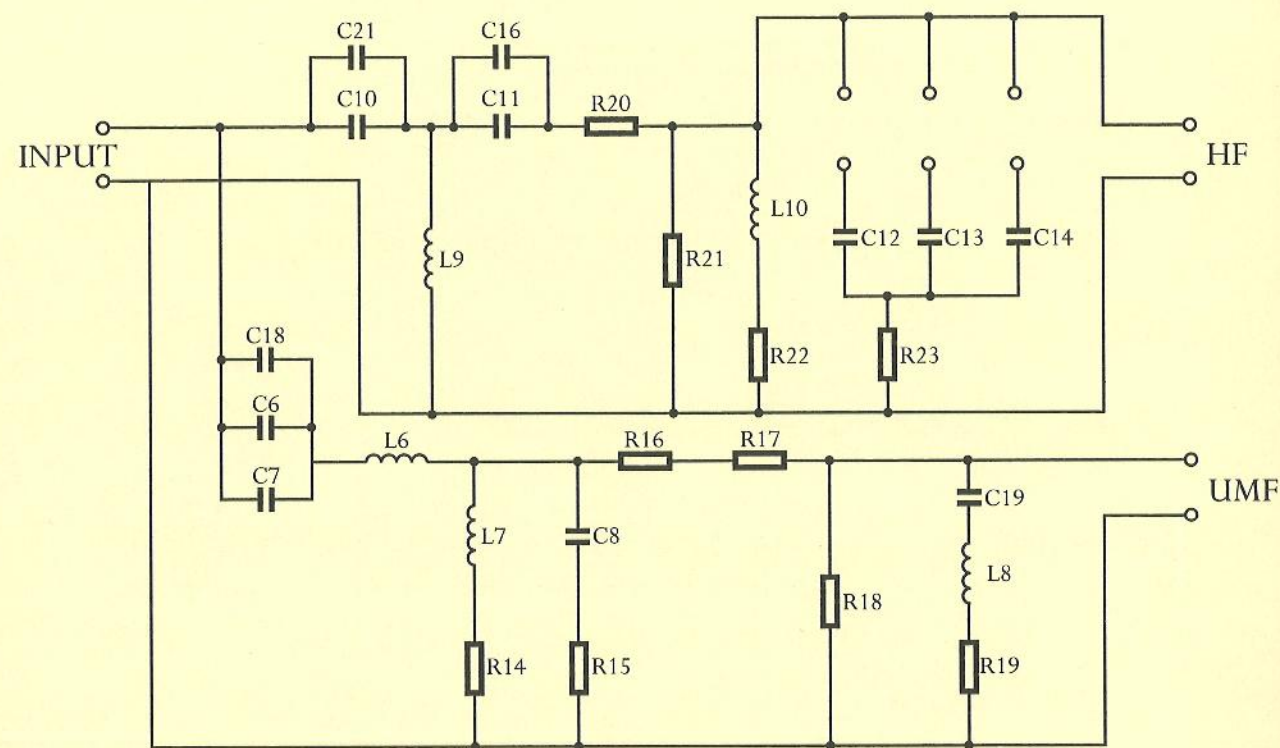

TECHNICAL SPECIFICATION

System type 4-way reflex

Drive Units

Low frequency 380mm (15") doped paper cone, cast chassis, double suspension, underhung voice coil
 Lower mid frequency 250mm (10") doped paper cone, cast chassis, underhung voice coil
 Mid frequency 160mm (6") doped polypropylene cone, cast chassis
 High frequency 25mm (1") fabric dome, ferrofluid cooled

Cabinets

Low frequency 145 litre internal volume, 25mm braced MDF, 50mm MDF baffle
 Lower mid frequency 19 litre internal volume, 25mm braced MDF
 Mid frequency 6.5 litre internal volume, 25mm braced MDF

Crossover Frequencies 100Hz, 400Hz, 2.8kHz

Crossover Slopes LF - LMF 2nd order LF / 4th order LMF
 LMF - MF 2nd order
 MF - HF 4th order

Frequency Response 35Hz - 20kHz \pm 3dB

LF -6dB 30Hz

Sensitivity 91dB (2.83V/1m)

Maximum SPL 118dB

Amplifier Requirements 50 - 400W

Power Handling 400W

Impedance 4 Ohms (Nom.)

Weight 87kgs (191.4lbs)

Dimensions 1188 x 600 x 671mm (46.8 x 23.6 x 26.4inches)

WARRANTY AND SERVICE

Your KEF Reference Series Model 109, The Maidstone, loudspeakers are guaranteed against manufacturing defects in both materials and workmanship. For further details on how this guarantee affects you, please read the enclosed warranty leaflet. It should be noted, however, that failure of the loudspeaker due to abuse, improper or inappropriate use and/or operation or damage caused by other faults in your system are NOT covered within the terms of the guarantee. The warranty is also void if the serial numbers have been removed or defaced.

Service problems should be discussed in the first instance with the dealer from whom the speakers were originally purchased. Generally, warranty claims are best handled by your dealer.

